

Data centres – Solutions for more safety and efficiency

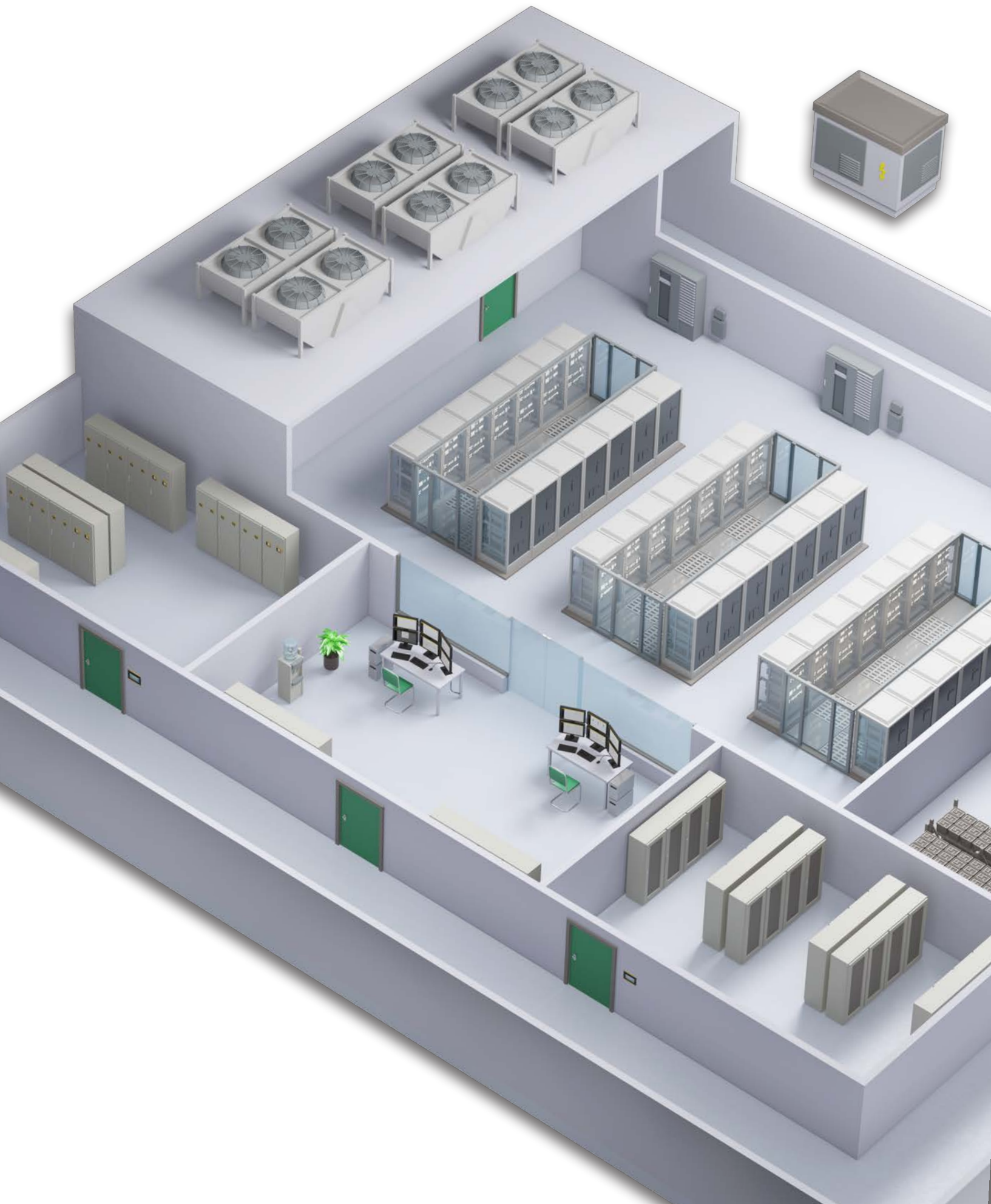

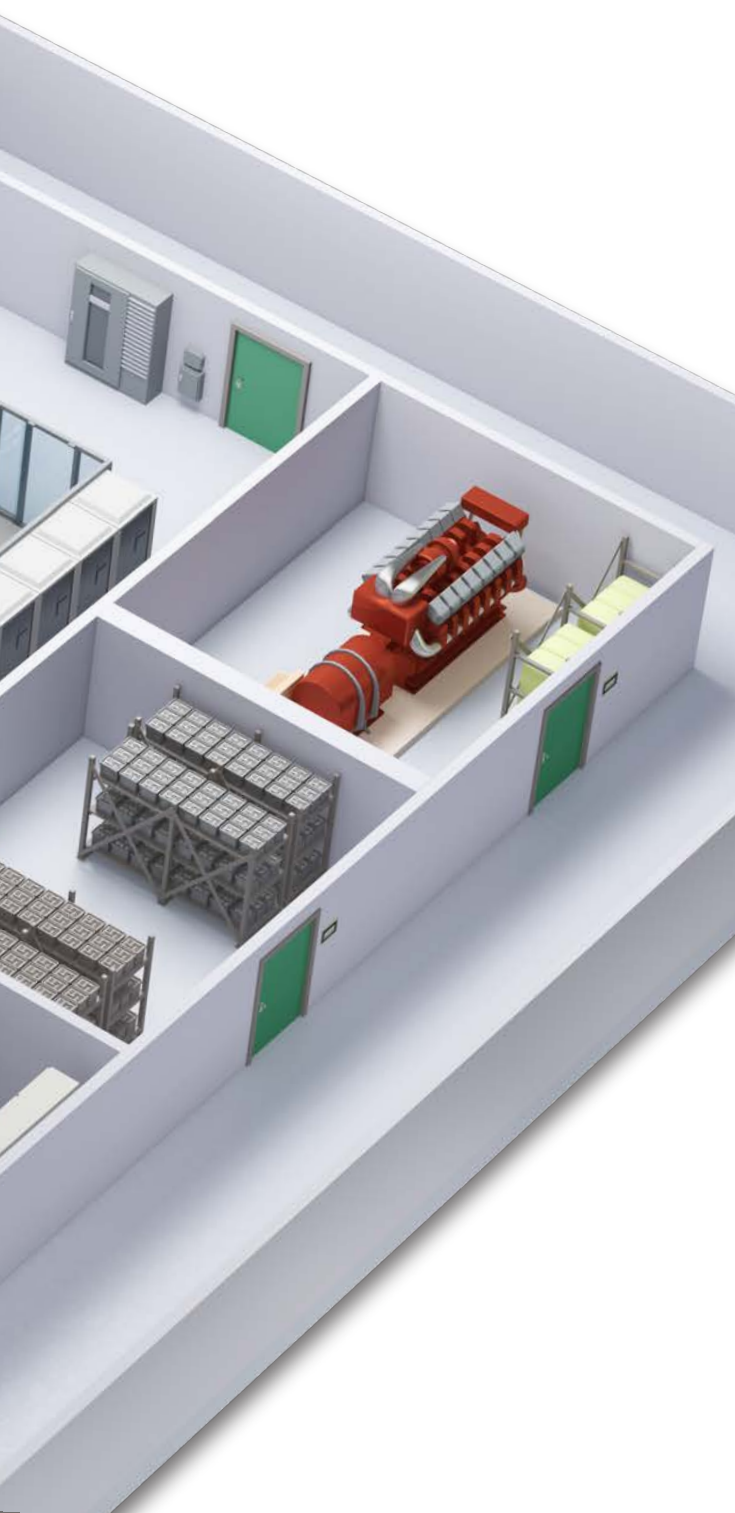

Bender solutions for more safety and efficiency



Safety, maximum availability and economic efficiency are a MUST in server parks, data centres and IT rooms, and require disturbance-free power supply. A failure or a fault in these highly available IT systems/installations may lead to considerable costs. Through continuous monitoring of the quality of the electrical power supply, these problems can be detected and prevented in time.

Electrical safety in data centres

	Page
Maximum availability in data centres	4
Continuous monitoring of your system	6
The data centre standard EN 50600	7
Monitoring according to standards	9
Continuous monitoring of the residual currents.....	10
Measuring without switch off, German Social Accident Insurance (DGUV) regulation 3.....	11
Fire protection.....	12
Power consumption recording	13
System control centre	14
Bender Remote Assist.....	15

Safety, maximum availability and economic efficiency for power supply in data centres

Data centres are designed to operate IT components without interruption and to secure the availability of the IT via appropriate redundancies. Nowadays, data centres must be able to manage high performance, availability and optimal utilisation of resources in an economically reasonable way. In order to ensure this high availability combined with electrical safety, complex power supply systems and components are employed.

Operational failures, faults or interruptions of a data centre are among the worst-case scenarios for operators and persons in charge. If these are caused by avoidable faults, the impact is even greater, since every failure or fault in these highly available IT systems and installations can lead to considerable costs. Through continuous monitoring of the quality of the electrical power supply, these problems can be detected and prevented

in time: Monitoring critical parameters such as temperature, humidity, dew point, fire, movement etc. is part of the basic equipment of any data centre.

Bender systems ensure continuous monitoring of the electrical installation. Thereby, they allow reliable operation of the electrical power supply, since, despite a design complying with the standards, modern loads increasingly cause faults in electrical installations. Bender systems allow reliable operation of the electrical power supply.

A fault-free power supply and thereby uninterrupted operation is a basic requirement for the safety of humans and machines.

- Improved operational safety due to early detection of a potential critical system status
- Extensive protection of persons and installations against hazards caused by electrical current
- Higher productivity
- Clear reduction in operating expenses
- Time- and cost-effective maintenance

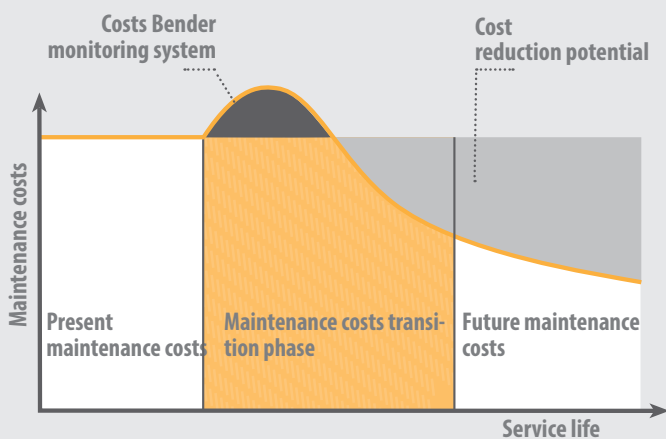

Bender monitoring systems ensure fault-free power supply and thereby offer convincing advantages to the operator of electrical installations.



In order to be able to meet the high requirements regarding availability and safety in modern data centres, it is not enough to deal only with load distribution, capacity planning and switchable current circuits in the area of infrastructure and electrical power. It is of special importance to go into detail with the subject of electrical power and to also detect and evaluate fault currents, equalising currents and insulation faults in a finely granulated way.

Insulation faults, stray currents, overloaded N conductors due to harmonics or asymmetrical loads, interruptions of PE and N conductor and also EMC influences can interfere with the entire

current supply system and have an impact on the operation. The effects go from triggering several protective devices, corrosion of pipeline and lightning protection systems over unexplainable malfunctions of IT systems to fire damage or even injury to persons. Depending on the damage location and the availability class of the data centre, costs of >100,000 euros are not uncommon.



Improved economic efficiency

- Avoiding expensive and unplanned system shutdowns
- Reducing time and staff expenses for maintenance
- Detecting weak points in systems
- Supporting investment decisions



Optimised maintenance

- Early detection and reporting of insulation degradation
- Automatic localisation of faulty current paths
- Optimised use of time and staff resources
- Central information regarding system status
- Remote diagnosis via Internet/Ethernet



Improved fire protection

- Early detection of fire hazardous insulation faults
- Minimising fault arcs as a common cause of fire

Why continuous monitoring of the system is important

Maximum availability requirements are placed on data centres. Therefore, the long-term sustainability of the power supply must be ensured. It goes without saying that the power supply of the data centre itself and all areas in the same building to which data cables are run must be designed as a TN-S system. Continuous self-monitoring of a "clean" TN-S system (e.g. with RCMs) and displaying the alarms at a location that is always manned, e.g. a control centre, is absolutely necessary for reliable operation. An electrically skilled person recognises the need for action via the respective alarms and can avoid damage thanks to specific service measures.

A reliable statement regarding the state of the power supply is only possible via a continuous system monitoring and analysis. Therefore, the following values must be measured at important nodes of the power supply in real time and recorded for future evaluation:

- Currents, voltages and frequencies on all five conductors
- Active, reactive and apparent power
- Frequency level
- Residual currents DC...2 kHz

With these measured values, experts can obtain important additional information regarding the operating mode of the TN-S system.

- Current via the CEP
- Current of each conductor (L1, L2, L3, N, PE)
- Residual currents via the three phases and the N conductor (L1, L2, L3, N)

Only with these real/time recordings, time periods can be detected and the causes of the respective faults can be determined.



The data centre standard EN 50600

In the future, a standard-compliant data centre must meet clear requirements regarding availability and protection classes as well as energy efficiency. These requirements are defined in the seven parts of the EN 50600.

Until now, there were different standards for the individual technical components of a data centre. The new European standard EN 50600 regulates for the first time all aspects of the installations and infrastructure. Now also the conception and planning of the infrastructure as well as the operational management are taken into account.

Regarding the availability, the standard describes availability classes in the proven four-stage system.

Directives and regulations of EN 50600

The DIN EN 50600 represents the first transnational standard that provides comprehensive guidelines for a holistic approach to the construction of a new data centre and therefore has a great impact on the sector. It specifies the requirements concerning the construction planning of the trades building construction, power distribution, air conditioning, cabling, security systems and describes the requirements for the operation of the data centre.

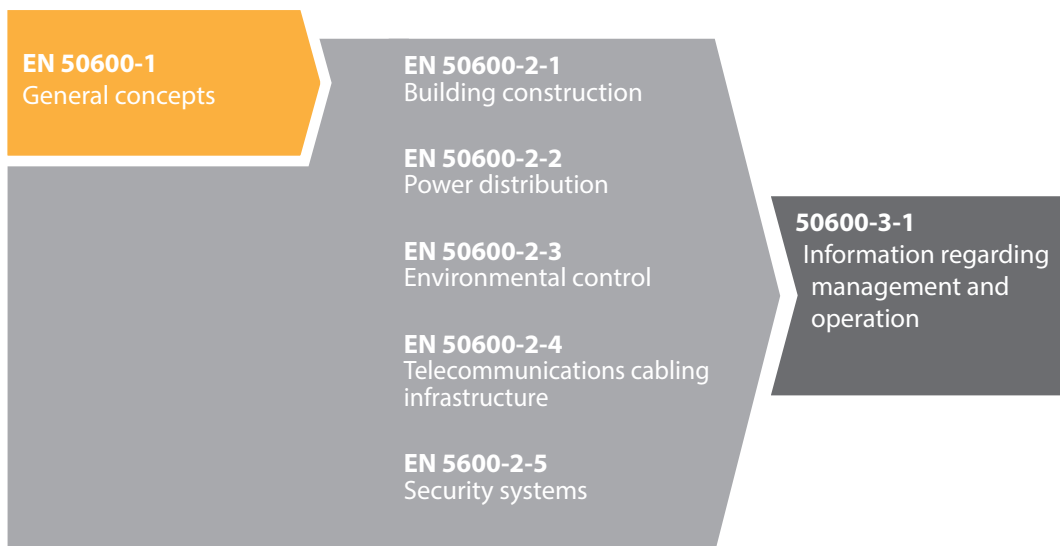

The data centre standard EN 50600

Bender technology for all levels of granularity

In the harmonised DIN EN 50600-2-2:2014-09; VDE 0801-600-2-2:2014-09, three granularity levels are defined with regard to the ability of energy efficiency, which contain the measuring points on which the power consumption of the electrical installations and infrastructures of a data centre is measured.

- Single-phase measurement and neutral conductor measurement at L1, L2, L3, N with Bender PEM technology
- AC/DC sensitive RCM monitoring L + N (at the outgoing circuits of the distribution systems)
- Monitoring of the central earthing point (CEP) with RCM technology

Granularity levels

Level 1: simple information for the entire data centre

Level 2: detailed information for specific installations and infrastructures of the data centre

Level 3: granular data for individual elements of the data centre

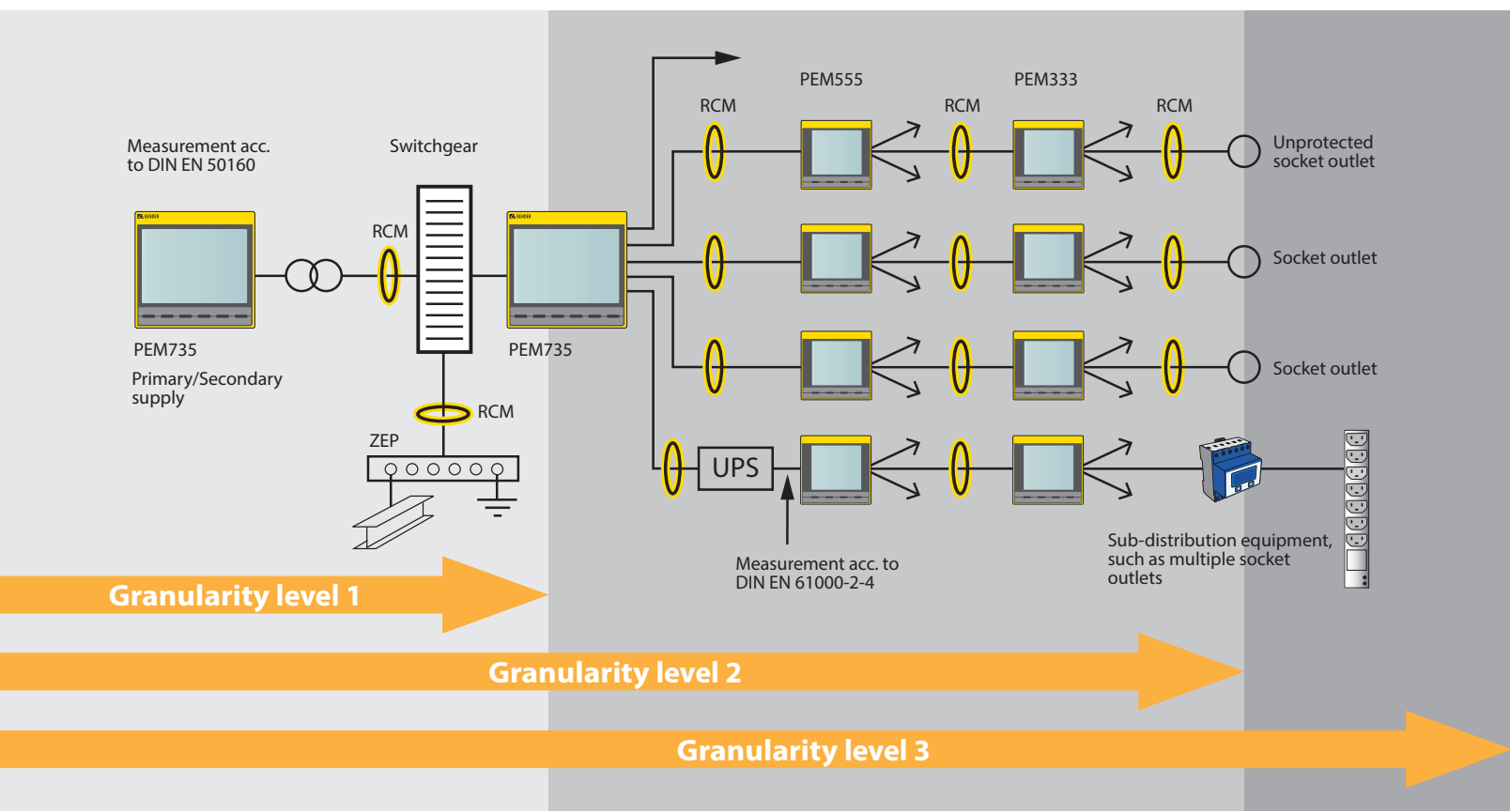

Monitoring of power quality and the CEP (total fault current in the TN-S system)

Monitoring of sub-distribution boards, outgoing circuits and individual main loads with fault current detection

Monitoring of individual loads and socket outlet circuits

Monitoring according to standards

Monitoring the power quality according to DIN EN 50160

System shutdowns due to premature material fatigue are costly. Often, power quality problems can be identified as the cause. In order to enforce recourse claims it might be necessary to provide proof of compliance with the permitted limit values. This proof is provided by a certified class A (DIN EN 61000-4-30) network analysis device, such as the PEM735.

A voltage quality report describes the minimum current and voltage quality needed for fault-free operation of the data centre. The voltage quality after secured power supply systems must comply with the EN 61000-2-4 class 1.

Monitoring of the central earthing point (CEP)

For EMC-compliant operation of electrical systems, an installation in the TN-S system with a single central earthing point (CEP) is required. To maintain the status during the entire service life of the system, the CEP must be continuously monitored.

The entire system leakage current flows through this measuring point. Abrupt changes in the measured leakage current indicate a new PE-N bridge, a PE-N swapping or a low-resistance earth fault. Via the history memory of the monitoring devices, it can be determined when significant changes occurred. The cause (e.g. maintenance work on installation parts) can be detected and the fault location can be determined.

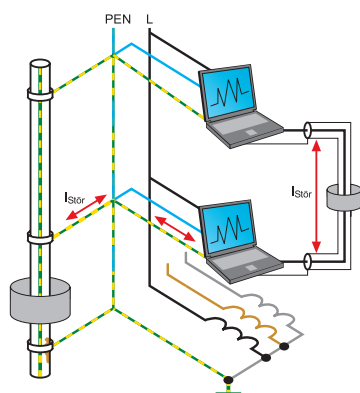

EMC-unfavourable TN-C system (4 conductors)

Transparency in electrical installations

Monitoring the power quality with a PEM735 is done close to a coupling point, thus at the feeding point. Merely evaluating the power quality at this central measuring point does not enable to detect and localise the cause. It is recommended to employ several permanently installed power meters with different measurement functions. The range of measurement functions decreases from the distribution towards the final circuit. Thereby, individual outgoing circuits can be monitored in the main distribution board with a PEM555 (high-resolution waveforms, harmonics up to 63rd, ...). In the sub-distribution, a PEM333 records the total harmonic distortion (THD) of final circuits. In the event of a fault the cause can be detected from the feeding point up to the final circuit via the measuring values.



Continuous monitoring of residual currents: Availability without additional protection

Since 2007, the DIN VDE 0100-410 requires an additional protection for alternating current circuits in the exterior area and those containing sockets with a rated current not exceeding 20 A, designated to be used by lay persons and for general use. This consists of a residual current device (RCD) with a rated residual current not exceeding 30 mA.

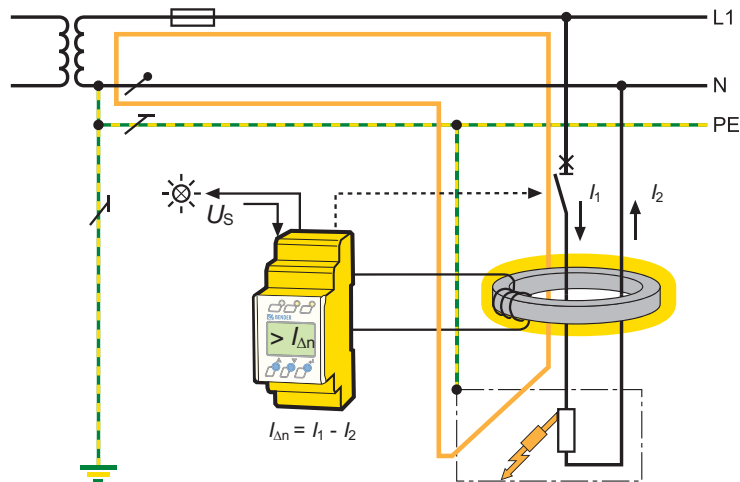

RCM principle

However, exceptions can be made for systems in the industrial or commercial area that are monitored by electrically skilled persons and if metrological measures ensure that damages can be detected and remedied in time. This metrological measure can be done via residual current monitoring systems. This system consists of multi-channel recording devices (RCMS), sensors adjusted to the installation (e.g. AC/DC sensitive residual current sensors) and a suitable evaluation device that registers changes and indicates alarms in the event of a fault (e.g. via e-mail notification).

DIN VDE 0100-530:2011-06 531.3.2

If electrical equipment that can generate direct fault currents is permanently installed on the load side of a residual current device (RCD), the residual current device (RCD) must be of type B or type B+.

If it is known that equipment/loads to be connected cause a DC component in the fault current that is incompatible with type A, and if for this current circuit the fault protection according to DIN VDE 0100-410 (VDE 0100-410):2007-06, 411 is carried out with a residual current device (RCD), these must be of type B or of type B+.

Continuous monitoring of residual currents: Measuring without disconnecting according to the German statutory accident insurance (DGUV) regulation 3 (BGV A3)

The employers are responsible for the safety of their employees. Among other things, the hazards of electrical installations and equipment must be evaluated and the requirements of the German statutory accident insurance DGUV regulation 3 (formerly BGV A3) or DGUV regulation 4 for public accident insurers (formerly GUV-V A3) must be complied with.

In order to maintain the correct status of electrical installations and stationary electrical equipment a periodic test must be carried out. The §5 sect. 1 No. 2 of the DGUV regulation 3 says that this requirement is also met if the system is continuously monitored by electrically skilled persons. According to this regulation, systems are continuously monitored when they are continuously maintained and tested applying metrological measures when operating (e.g. monitoring the insulation resistance) by electrically skilled persons.

Continuous monitoring with multi-channel residual current monitoring systems (RCMS) and an evaluation (CP700) adapted to the system enable the electrically skilled person in charge to adjust the time limits for the insulation test within the context of periodic tests.



Protection against fire

Continuous monitoring of residual currents

Partial (resistive) short circuits or earth faults are a special fire hazard if at the position of the arc, relatively low resistances occur in the fault current circuit. Disconnection of the fault via upstream overcurrent protection devices such as fuses or circuit breakers is not given. With a heat capacity of > 60 W the presence of oxygen can already lead to an ignition.

In this case, the residual current device (RCD) with a rated residual current $I_{\Delta N}$ of 300 mA offers comprehensive protection. If in specific application cases a residual current device (RCD) cannot be used for technical reasons, the directives for damage prevention of property insurers (VdS) recommend the use of residual current monitors (RCMs) acc. to DIN EN 62020 (VDE 0663) with switching devices, e.g. circuit breakers, if their supply voltage is isolated from the supplying system (see: VdS2033).



LINETRAXX® RCMS460

Continuous monitoring of residual currents

By using several single-phase loads with electronic power supply units, high harmonic components are generated in the current. The so-called 3-n harmonics (all multiples of 3) form a zero sequence component and sum up in the neutral conductor. The result: highly loaded and overloaded neutral conductors.

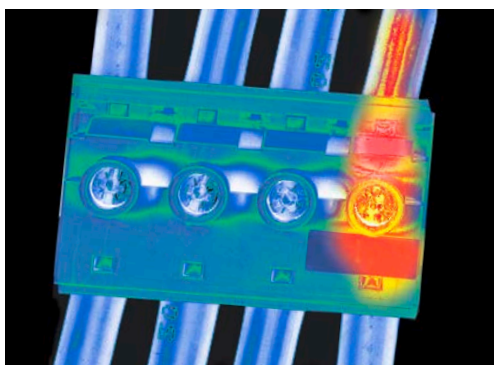

Overload of the neutral conductor

An overload of the neutral conductor can directly cause a fire. Often, the high load on the neutral conductors already constitutes a problem: as an additional current-carrying conductor, the neutral conductor increases the generation of heat in cables and wires. The operating status often differs from the assumed current-carrying capacity at the time of planning (laying procedure, thermic consideration, fuses). Monitoring the neutral conductor currents with an adequate power meter (e.g. PEM555) can expose critical system conditions and thereby reduce the fire risk and prevent failures.

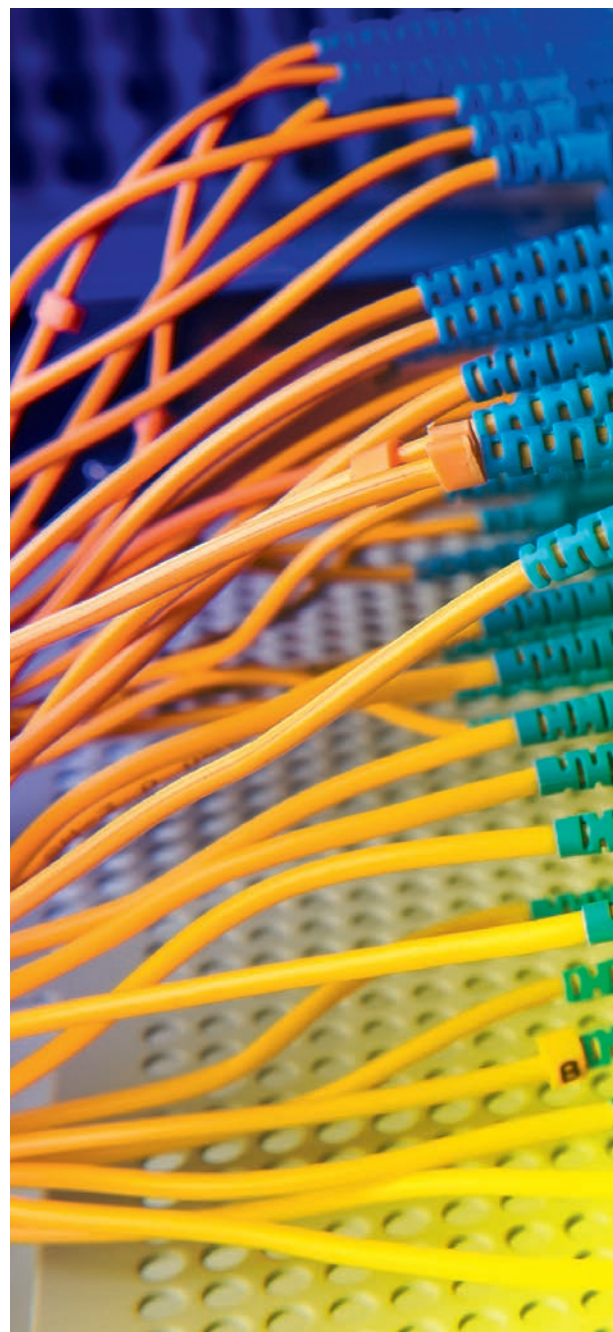

Power consumption recording

Due to rising energy costs, the subject of energy efficiency is becoming more important. However, useful measures for energy saving can only be determined when the energy flows in the system are known. Energy meters for DIN rail mounting but also power meters for front panel mounting like the PEM333 can be used for this purpose. In addition to the energy meter, a power meter provides information regarding harmonic content and can be involved in the fault location in the event of a fault. The system control centre (CP700) collects measuring values from recording devices via Modbus RTU and makes the information regarding energy consumption and power flow centrally available.

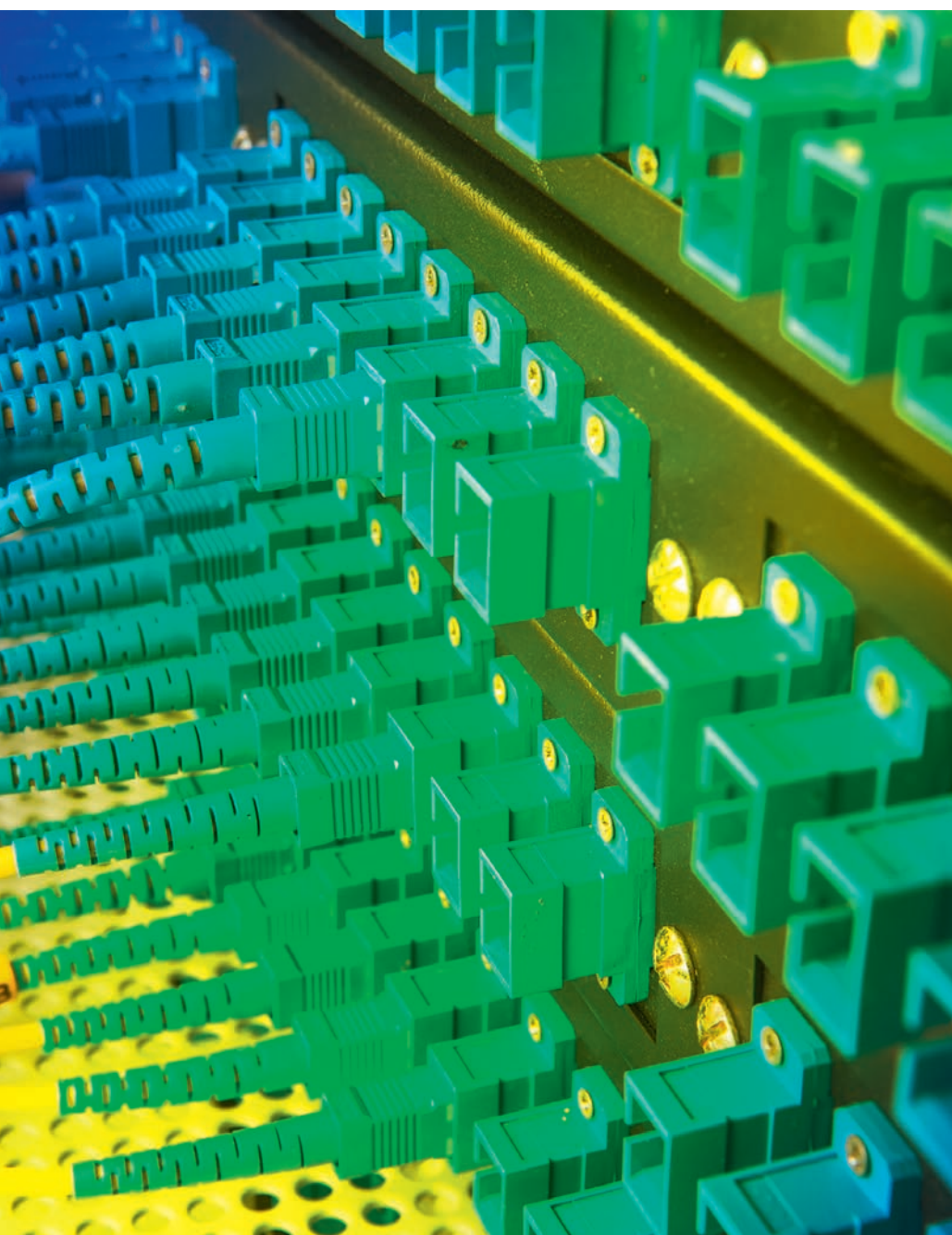
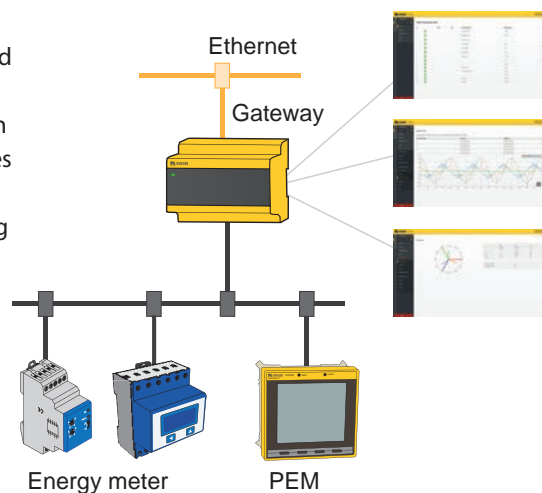

Visualisation and gateways

The LINETRAXX® monitoring systems are used in a wide range of applications. However, what they have in common is that the user can obtain relevant information in a fast and easy way. In the event of an alarm, the system informs actively via e-mail, switching contacts or transfer of information to higher-level control systems. To carry out an analysis or to create a report, the user accesses data points from the past. The Bender system control centre allows both in one system. Data is collected from all connected measuring devices, evaluated and processed according to the respective application. Thereby, the browser-based concept offers many advantages:

- Remote access to the current measured values, status/alarm messages and parameters via LAN/WAN Internet
- All users work live in a browser-based system
- 10/100 MBit Ethernet gateway for Modbus TCP, Modbus RTU and Profibus DP and support for third-party devices
- Central management
- The system is safe and geared toward the future with expansions

From the entire system overview with integrated visualisation tool to detailed power quality evaluations, the Bender system control centre accompanies the user with intuitive operation and guided support during fault analysis.

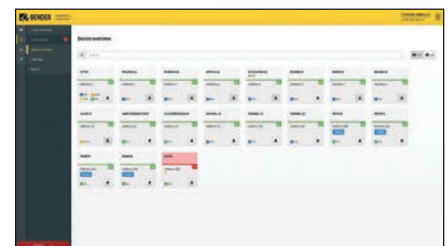
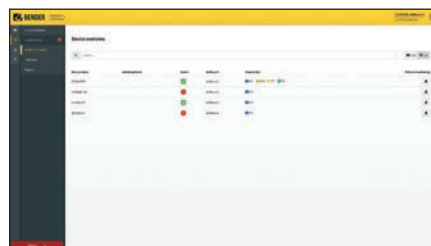
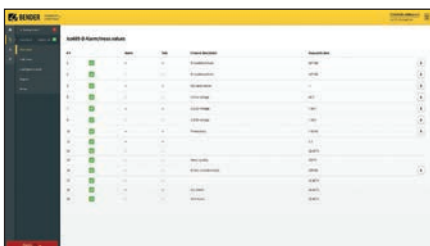

Indication of device data on the web user interface (COM465IP)

Bender Remote Assist

Ensuring a consistent high level of safety for installations, which are becoming more and more complex – this is a task that represents a growing challenge to system operators.

Due to different communication technologies, expanding function range as well as continuously changing standards it becomes more difficult to assess values and faults. Usually, the result is major damage caused by not properly maintained installations, incorrect parameter setting, no adjustment of the devices to the ageing process of the installation as well as failure to observe significant system faults, which can lead to a long downtime.

Bender Remote Assist offers you support with this task via remote access, high-quality service and advice. Make use of the advantages of fast, efficient support and advice by our expert network for the highest possible availability of your installation.

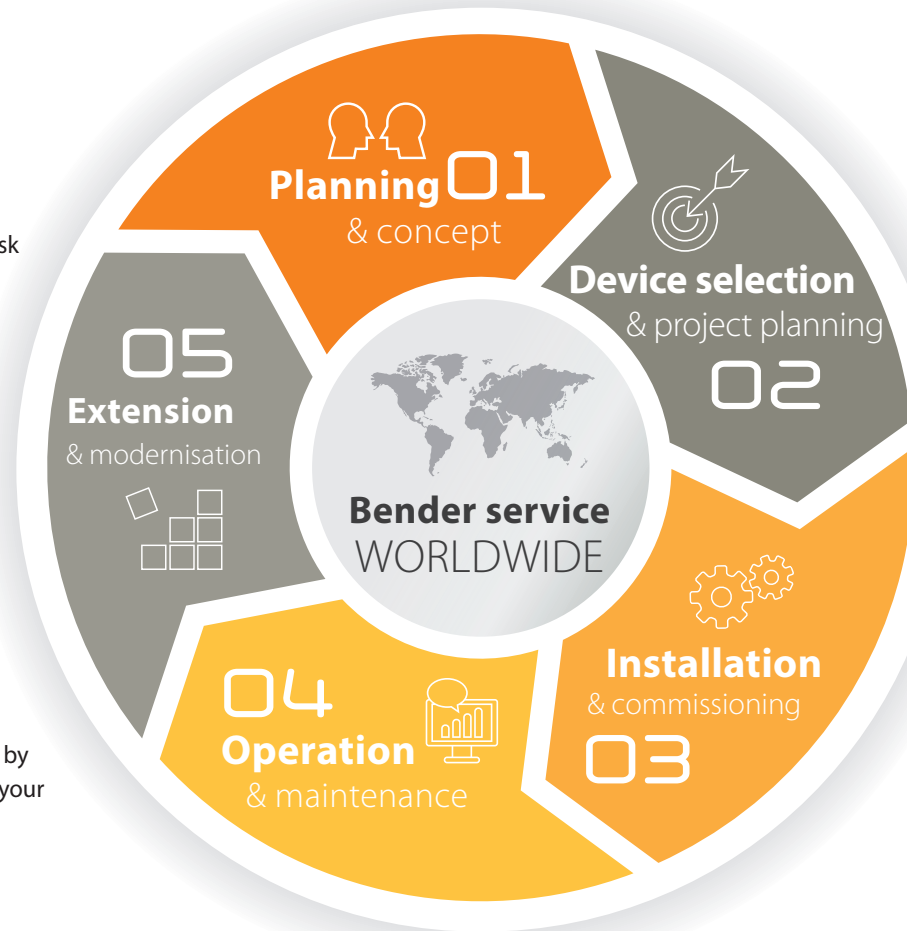

Expert network

The entire Bender expert team is available to you at all times. Hereby, whenever you are in need of it, you will receive support from a sector-specific specialist, who knows your installation to the smallest detail.

Your benefits:

- Perfect installation diagnosis due to Bender-internal expertise
- Detection of sector and installation-specific problems by experts

Operational support

While operating your installation, you will continuously receive remote support through regular system checks. This not only saves time in maintenance, but also helps anticipating maintenance measures. Thus working with the systems becomes easier and faster.

Your benefits:

- Faster response times and higher availability
- Reduced and predictable costs, avoidance of service visits



Bender GmbH & Co. KG

P.O. Box 1161 • 35301 Gruenberg • Germany
Londorfer Straße 65 • 35305 Gruenberg • Germany
Tel.: +49 6401 807-0 • Fax: +49 6401 807-259
E-mail: info@bender.de • www.bender.de

Photos: 123RF (© dotshock), Fotolia (© elgris, © miklyxa, © xiaoliangge), Istockphoto (© Eimantas Buzas) and Bender archives.



BENDER Group