

# MarinaGuard<sup>®</sup>



**MG-T**  
**Ground Fault Monitoring Panel**  
**For Marina Shore Power**

# Table of Contents

<b>1. Introduction.....</b>	<b>4</b>
1.1 MarinaGuard .....	4
1.2 Monitored Circuit.....	4
1.3 Current Transformers.....	4
<b>2.Safety Instructions.....</b>	<b>5</b>
2.1 General Safety Warning .....	5
2.2 Using This Manual.....	6
<b>3.Installation and Connection .....</b>	<b>7</b>
3.1 Internal Components.....	7
3.2 Dimensions.....	8
3.3 Mounting .....	9
3.4 Conduit .....	9
3.5 Wiring - General Instructions .....	10
3.5.1 Wire Size and Type .....	10
3.5.2 Wire Strip Length.....	10
3.5.3 Recommended Tightening Torque.....	10
3.6 Wiring .....	11
3.6.1 Control Power and Ground Connections .....	11
3.6.2 Current Transformer Connections .....	12
3.6.3 External Trip Circuit Connections.....	13
3.6.4 Wiring Block Diagram Reference.....	15
3.7 Current Transformer Installation.....	16
3.8 Field Adjustments - MGT.3.....	17
3.8.1 RCMS490 Multi-Channel Ground-Fault Relay .....	17
3.8.2 Main Alarm .....	17
3.8.3 Pre-Trip Alarm.....	17
3.8.4 Time Delay .....	17
3.8.5 Digital Display.....	17
3.8.6 RCMS490 Interface Elements .....	18

3.8.7	Password Protection .....	19
3.8.8	Disable Unused Channels.....	20
3.8.9	Change Trip Levels .....	21
3.8.10	Change Pre-Trip Alarm Level .....	22
3.8.11	Change Trip Time Delay .....	23
3.8.12	Change Password.....	24
3.8.13	Factory Default Settings Table.....	25
<b>4.</b>	<b>Operation.....</b>	<b>27</b>
4.1	Panel Interface Elements .....	27
4.2	Applying Power .....	28
4.3	Performing a Functional Test .....	28
<b>5.</b>	<b>Troubleshooting.....</b>	<b>29</b>
5.1	General Troubleshooting.....	29
5.2	Fuse Replacement .....	29
5.3	Error Codes.....	30
5.4	Technical Specifications.....	30
<b>6.</b>	<b>Ordering Information .....</b>	<b>31</b>
6.1	MarinaGuard .....	31
6.2	Current transformers .....	31
<b>7.</b>	<b>Certifications.....</b>	<b>33</b>
7.1	MarinaGuard .....	33

# 1. Introduction

## 1.1 MarinaGuard

MarinaGuard UL Listed Ground-Fault Protection Panels detect ground faults in feeder and branch circuits of electrical systems in marinas, boat yards, floating buildings, docking facilities, and similar locations. When correctly installed, MarinaGuard panels satisfy the requirements of National Electrical Code 555.35 (A) & (B)(1), 555.53 & 682.15 (B) (2023 edition); NEC 555.32, 555.35 (A)(1) & (3), 555.53, & 682.15 (B) (2020 edition); NEC 555.3 & 682.15 (2017 and earlier editions); and Canadian Electrical Code 78-052. MarinaGuard panels fall under Overvoltage Category III installation. The trip level can be set below the maximum Code-allowed trip level, if desired and the trip time can be adjusted for coordination with downstream protection. External current transformers, purchased separately and installed in distribution equipment, are used for measuring ground-fault current. Shunt-trip circuit breakers are required to interrupt the faulted circuit in the event of a ground fault. MarinaGuard panels require a site-supplied 120-Vac control voltage.

MarinaGuard features a lockable non-metallic type 4X enclosure suitable for outdoor use. A red strobe light mounted to the top of the enclosure provides clear visual indication of a trip or internal malfunction, and a "weep" fitting allows condensed moisture to drain.

## 1.2 Monitored Circuit

The MG-T.3 provides monitoring for up to twelve individual circuits from a single panel. The monitored circuits can be any combination of single, split, and three-phase configurations. A ground fault in a on the load side of a current transformer will be detected and the appropriate interrupter (typically a circuit breaker) will be tripped.

## 1.3 Current Transformers

Each monitored circuit requires a single ground-fault current transformer installed in the electrical-distribution equipment, with its secondary winding connected to the MarinaGuard panel. Current transformers are ordered separately and must match application requirements. Bender CTAC\* are compatible with MarinaGuard panels. For use of other Bender type CTs (circular and rectangular), and core types (solid or split), please contact us for additional information.

## 2. Safety Instructions

### 2.1 General Safety Warning



# DANGER

Hazard of Electric Shock, Burn, or Explosion

Only qualified maintenance personnel should operate or service this equipment. These instructions should not be viewed as sufficient for those who are not otherwise qualified to operate or service this equipment. No responsibility is assumed by Bender for any consequences arising from use of this document.

Turn OFF all sources of electric power before performing any inspections, tests, or service on this equipment. Assume all circuits are live until they have been properly de-energized, tested, grounded, and tagged. Failure to observe these precautions will result in equipment damage, severe personal injury, or death.

Proper operation of this equipment depends on proper installation. Refer to NFPA 70, NFPA 70E, CSA Z462, and other relevant standards and codes for installation standards. Neglecting fundamental installation techniques will result in equipment damage, severe personal injury, or death.

Do not make any modifications to the equipment. Failure to observe this precaution will result in equipment damage or personal injury.

Use only manufacturer's and manufacturer recommended accessories with this equipment. Failure to do so may damage the equipment beyond repair.

To prevent unauthorized access, the panel should be locked unless being serviced by qualified personnel.

## 2.2 Using This Manual

Read these instructions carefully and become familiar with the equipment before attempting to install, operate, or service it. Throughout this manual, special messages may appear to warn of potential safety hazards or to call attention to information which clarifies instructions or procedures. Observe all safety messages that appear throughout this manual to avoid possible injury or death. An explanation of these symbols is given below.



**DANGER:** Indicates a hazardous situation which, if not avoided, **will** result in death or severe injury.



**WARNING:** Indicates a potentially hazardous situation which, if not avoided, may result in death or injury.



**CAUTION:** Indicates a potentially hazardous situation which, if not avoided, may result in injury or equipment damage.



**NOTE:** Provides additional information to clarify instructions for a product or procedure.

# 3. Installation and Connection

## 3.1 Internal Components

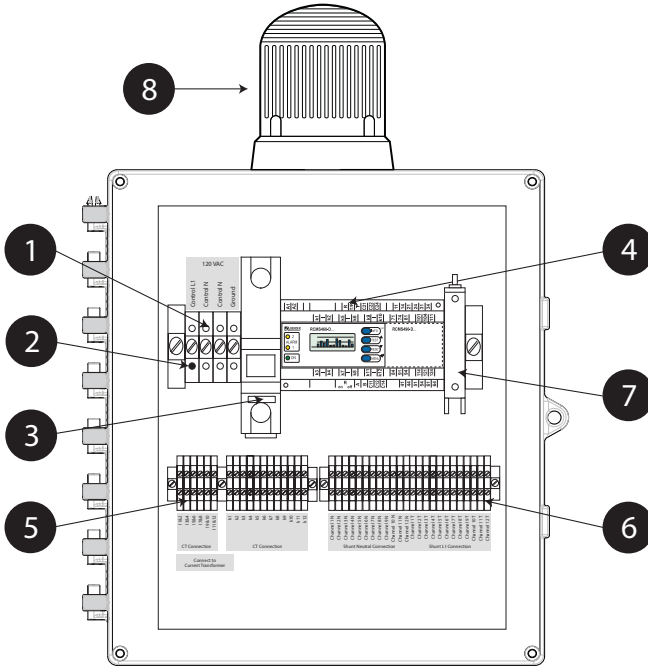

**Note:** For use in Overvoltage Category III

1	Terminal blocks for external 120 VAC control power and ground
2	Power indicating light - illuminates when control voltage is applied to panel, even if internal circuit breaker is open
3	Branch-circuit-rated circuit breaker - protects internal components and external trip circuits
4	RCMS490 multi-channel ground fault relay
5	Terminal blocks for external current transformers
6	Terminal blocks for external trip circuits
7	Fuse holder - contains fuse protecting RCMS490
8	Strobe light - flashes when ground fault is detected and circuit has tripped, or the RCMS490 malfunctions

### 3.2 Dimensions

Dimensions shown in inches (mm). Mounting feet are shown installed. A weep hole is provided on the bottom of the panel to comply with NEC 555.32 (2020 & 2023 editions) and 555.11 (2017 and earlier editions).

The enclosure is lockable.

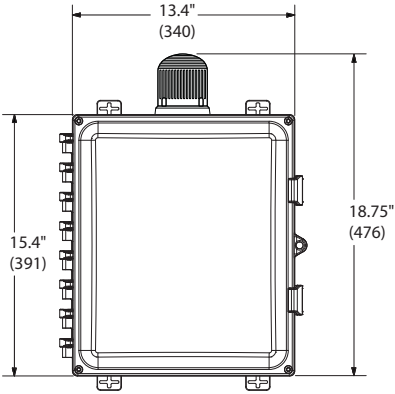

Front View with Strobe

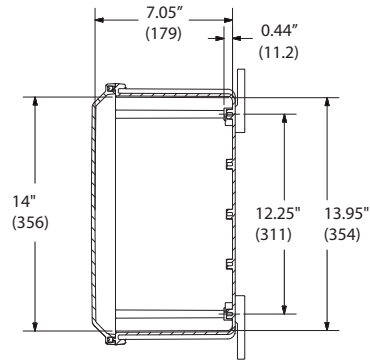

Side View

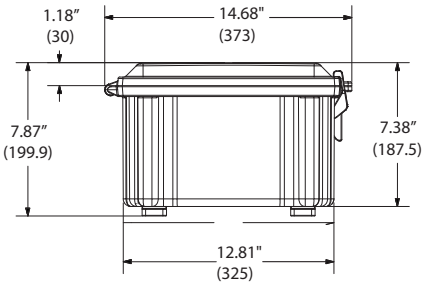

Bottom View

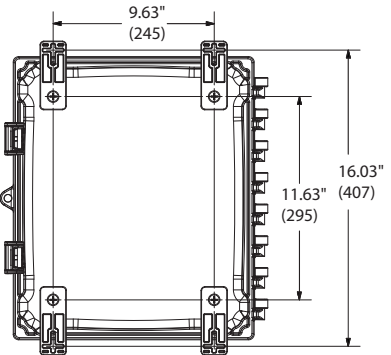

Rear View

Model	Weight
MG-T.3	10 lb. (4.5 kg)



### 3.3 Mounting

Mounting feet are included with MarinaGuard panels. Place the mounting brackets over the octagon bosses. Fasten them to the enclosure using the pro-vided 1/4"-20 x 0.25" SS countersunk Phillips drive screws (30 in-lb torque limit).



---

**NOTE:** *Mount the panel vertically, with the strobe light on the top.*

---

### 3.4 Conduit

- Conduit shall be installed at the lower left or lower right sides of the panel.
- Conduit holes may be cut using standard hole saws. Secure the conduit, the connector, and the locknut through a pre-drilled hole.
- For metallic conduit, secure a grounding bushing over the connector locknut. All threaded inserts in the enclosure and for cover attachment are brass #10-32.



---

**NOTE:** *Any fittings used must comply with any governing electrical code or requirements. Any fittings must also maintain the application-required enclosure rating.*

---

### 3.5 Wiring - General Instructions



**HAZARD OF ELECTRIC SHOCK, EXPLOSION, OR ARC FLASH**

This equipment must only be installed and serviced by qualified personnel.  
 Disconnect all power before servicing.  
 Observe all local, state, and national codes, standards and regulations when installing this equipment.

***Failure to follow these instructions will result in death or severe injury.***

#### 3.5.1 Wire Size and Type

Use minimum 22, maximum 14 AWG size wire. Use copper wire only. Current transformer connections must be made with 600 V rated conductors.

#### 3.5.2 Wire Strip Length

Type	Wire Strip Length
MG-T.3 - current transformer and shunt trip terminal blocks (labeled as numbers 5 and 6 in Section 3.1.2 (Page 9))	0.24" (6 mm)
All other terminal blocks in MG-T.3	0.39" (10 mm)

#### 3.5.3 Recommended Tightening Torque

Type	Tightening Torque
MG-T.3 - current transformer and shunt trip terminal blocks (labeled as numbers 5 and 6 in Section 3.1 (Page 7))	4.2 - 4.6 lb-in (0.5 N-m)
L1 Terminal block	7.0 lb-in (0.8 N-m)
GND Terminal block	6.8 lb-in (0.7 N-m)
Neutral Terminal block	6.8 lb-in (0.7 N-m)
Other Terminal blocks	4.6 lb-in (0.5 Nm)

## 3.6 Wiring

### 3.6.1 Control Power and Ground Connections

Locate the connections labeled as Number 1 in the diagram in Section 3.1 (Page 7). Refer to the wiring diagram below. Use 120 VAC, 60 Hz, grounded power only. Make connections to the top side of terminal blocks.

A branch-rated circuit breaker is provided to protect internal components, protect the external trip circuit, and allow connection to a feeder tap. Connection to a feeder tap increases the security of the ground-fault protection panel by making it electrically tamper resistant. Use a padlock to restrict access to internal components.

The L1 terminal block contains an indicating light, illuminating when control voltage is applied to the panel regardless of the state of the internal circuit breaker.

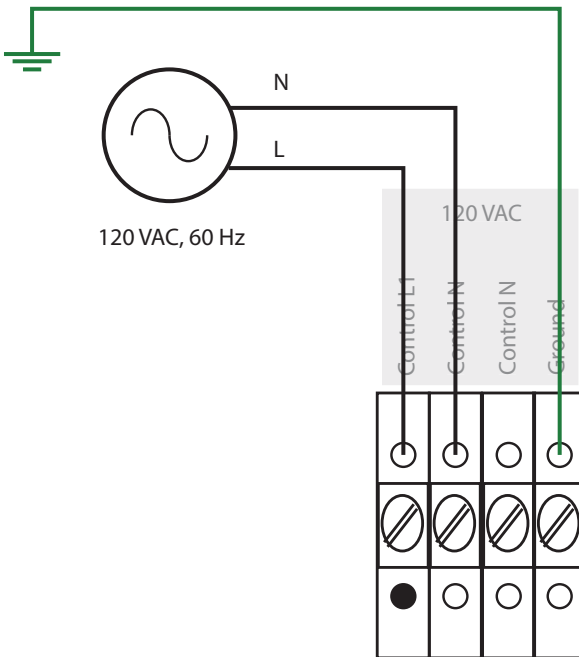

### 3.6.2 Current Transformer Connections

Locate the connections labeled as Number 4 in the diagram in Section 3.1 (Page 7). Up to twelve current transformers can connect to an MG-T.3 panel. Each CT monitors the active conductors on its load side, which can be a single circuit or feeder supplying branch circuits. Terminal “k” is an individual connection for each current transformer. Terminal “l” is a common terminal shared between up to two current transformers. Make the connections to the bottom side of the terminal blocks.

The diagram below shows example connections for three current transformers. Connect the current transformers sequentially. The diagram below shows example connections for current transformer. For alternative models or additional information, please contact us to speak with one of our application engineers.

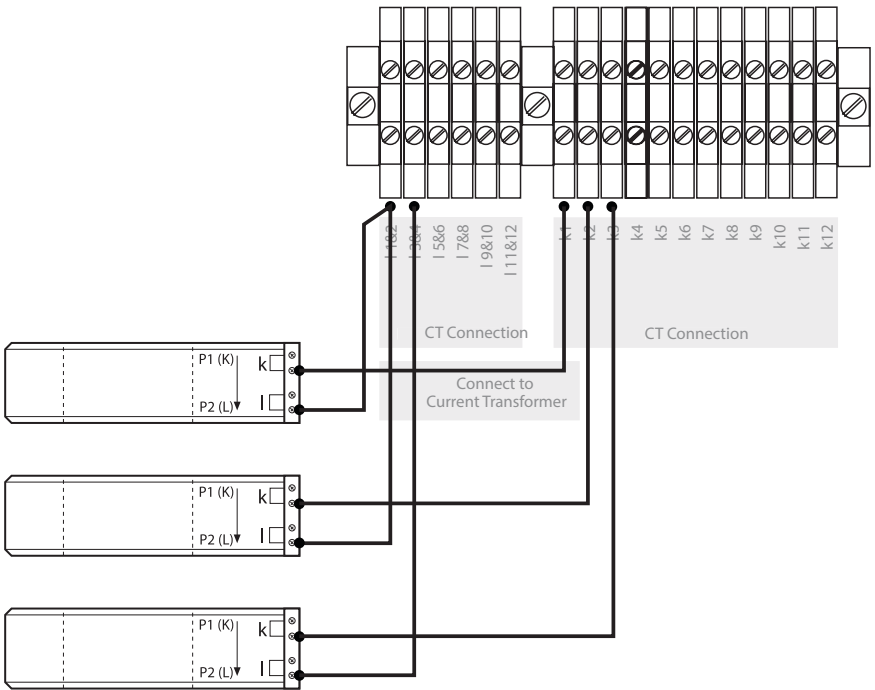

### 3.6.3 External Trip Circuit Connections

A powered, non-fail-safe (normally open), output is provided to connect to up to twelve interruption devices such as a shunt trip circuit breakers. Observe the following requirements when connecting an interruption device:

- Operation: Non-fail-safe, normally open, continuous closed when tripped
- Voltage: 120 VAC, 60 Hz coil
- Individual current draw: Minimum 1 mA, maximum 5 A



**CAUTION:** *The total current draw of all connected shunt trip coils must not exceed 12 A.*



**CAUTION:** *Do not connect interruption equipment that does not meet the requirements listed above. Connecting incompatible equipment may result in injury or equipment damage.*



**NOTE:** *Contact Bender if application requirements differ from those above, or if a separately derived trip voltage is required.*

Locate the connections labeled as Number 5 in the diagram in Section 3.1 (Page 7). The wiring diagram on the following page shows example connections for three shunt-trip circuit-breaker connections. Ensure that the connection number matches with the appropriate monitoring channel. Make the connections to the bottom side of the terminal blocks.

Before startup, the RCMS490 settings must be updated to disable any unused channels. Refer to Section 3.8.6 (Page 18) for more information.

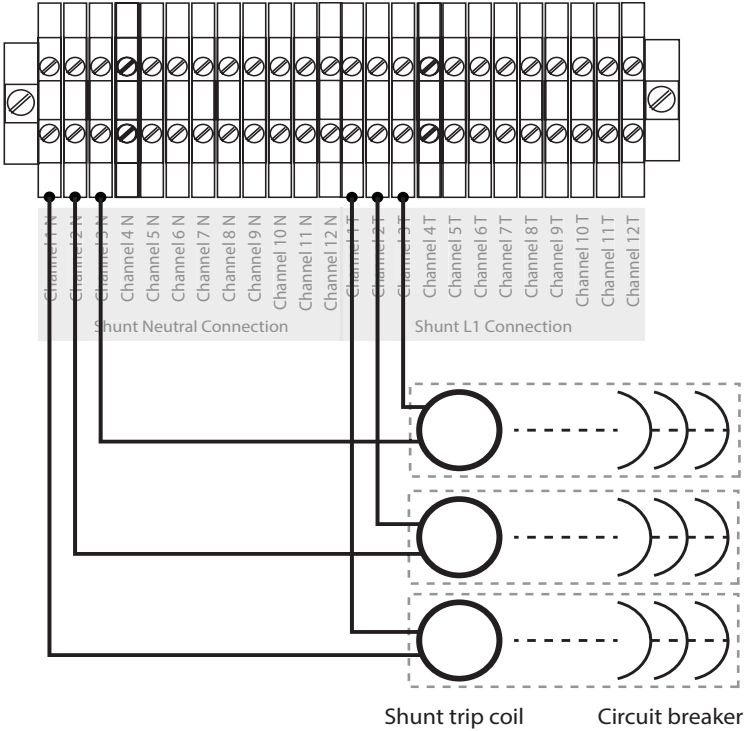

### 3.6.4 Wiring Block Diagram Reference

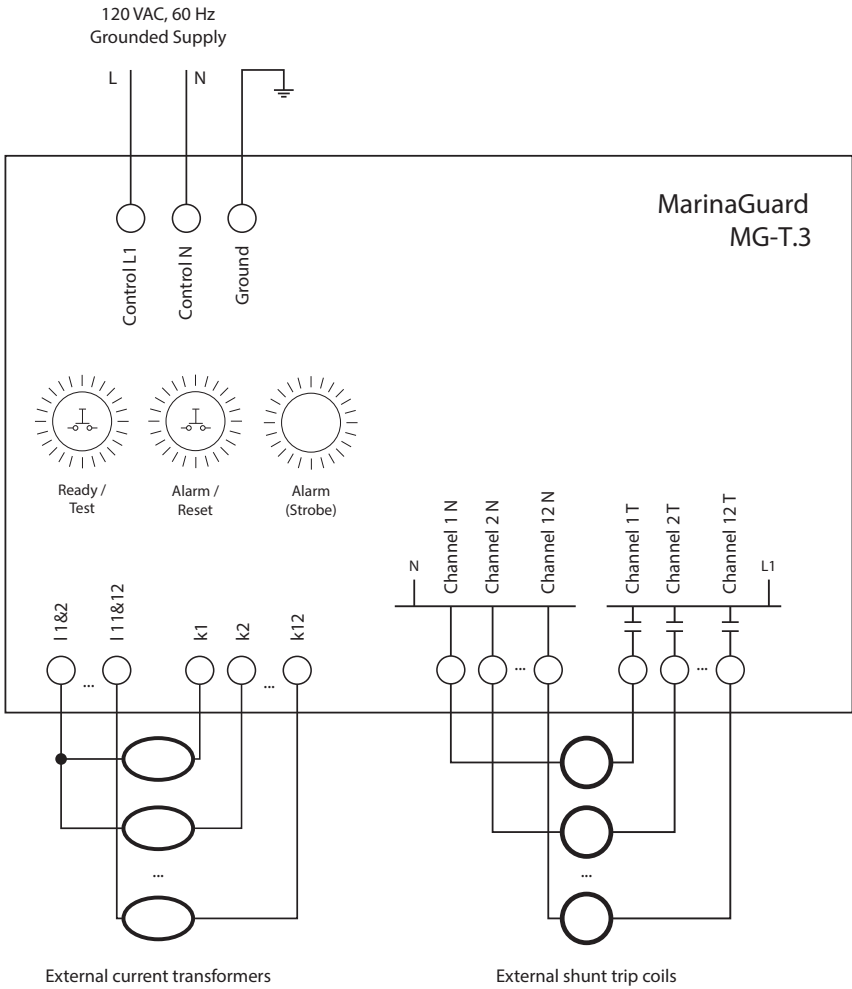

### 3.7 Current Transformer Installation

Install one current transformer on each circuit to be monitored. The current transformer will detect a ground fault on the load side of its location. Pass all active conductors of the monitored circuit, including the neutral if present, through the current transformer opening. Do not pass the ground conductor through the current transformer.

Ensure that the conductors are placed centrally through the opening. Direction (polarity) is unimportant. A monitored circuit will consist of two, three, or four conductors. Refer to figures below.



**CAUTION:** For proper operation, do not route the ground conductor through the current transformer.



**NOTE:** Only specified Bender current transformers are compatible. Refer to Section 6. for a list of devices. Third party current transformers are not supported.

*\*MG-T is intended for use with CTAC CTs*

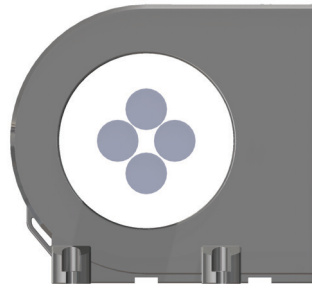
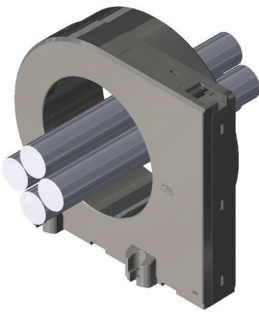



## 3.8 Field Adjustments - MG-T.3



**WARNING:** Do not change any settings other than those shown in this chapter. Incorrect settings may result in death, personal injury, or damage to equipment.

### 3.8.1 RCMS490 Multi-Channel Ground-Fault Relay

The MG-T.3 MarinaGuard incorporates a Bender RCMS490 multi-channel ground-fault relay, which monitors up to twelve separate circuits. Key settings affecting the performance of the MarinaGuard are listed below. For additional information on use, refer to the RCMS490 user manual.

### 3.8.2 Main Alarm

The RCMS490 has a trip-level range of 6 mA to 20 A. This value is individually adjustable for each channel to fit application requirements. A ground fault on any channel will turn on the strobe light and trip the interruption device associated with the faulted circuit. By default, all twelve channels are active and set to a 30-mA trip level.

### 3.8.3 Pre-Trip Alarm

The pre-trip alarm is indicated as a percentage of the main trip alarm value for each channel. For example, the factory setting is 70% of 30 mA, which equates to 21 mA. The pre-trip alarm percentage applies to all channels. The pre-trip alarm will only activate the RCMS490 LED AL1. Connected interruption devices will not trip and the strobe light will not activate.

### 3.8.4 Time Delay





The RCMS490 has a trip delay range of 0 to 999 s (factory setting 100 ms). The time delay is individually field adjustable for each channel for selective coordination of cascaded devices to minimize the number of de-energized circuits.

### 3.8.5 Digital Display

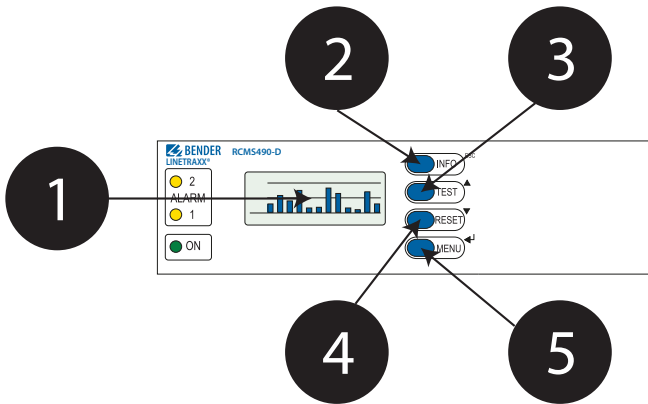
The RCMS490 has a digital display which shows the measured ground-fault current in real-time. Measurements are visualized as a bar graph showing all channels, displayed as a percentage of the trip setting. The display and pushbuttons are used to adjust factory settings. By default, the RCMS490 is password protected with password "100." No settings can be changed until this password is entered.

## 3.8.6 RCMS490 Interface Elements





1		Digital display Shows ground-fault current readings and menu options.
2		INFO / ESC button: Cancels settings entry or goes back a step in main menu.
3		TEST / UP button: Changes settings entry or scrolls up in main menu.
4		RESET / DOWN button: Changes settings entry or scrolls down in main menu.
5		MENU / ENTER button: Enters the main menu from the normal display. Confirms settings entry or enters next level in main menu.

### 3.8.7 Password Protection















When attempting to change any settings in the main menu, a prompt will appear to enter a password. Follow the steps below to enter the password. The factory setting is "100."

Once the correct password is entered, settings can be changed until leaving the main menu. Upon re-entering the main menu, the password must be entered again.

 	Press the UP or DOWN button until the correct digit is selected.
	Press the MENU button to confirm. Repeat these steps for the next two digits. After the third digit is entered, if the correct password was entered, the device will return to the previous menu item and settings will be modifiable until exiting the main menu.

### 3.8.8 Disable Unused Channels (Required)

By default, all twelve RCMS490 channels are active. Unused channels must be disabled to prevent connection error messages during regular use. Repeat these steps as needed until all unused channels are disabled.

	<p>Press the MENU button.</p>
 	<p>Press the DOWN button until "Settings" is reached. Press the MENU button to enter the Settings menu.</p>
 	<p>Press the DOWN button until "Channel" is reached. Press the MENU button. Password entry will be required. A number of individual channel options will appear.</p>
	<p>Press the UP button until the numbers at the top of the screen are flashing. This is the channel selection option.</p>
	<p>Press the MENU button. The channel to apply settings to will flash.</p>
 	<p>Press the DOWN button until the desired channel number is selected. Press the MENU button to confirm selection. Any settings changed now will only affect the selected channel.</p>
 	<p>Press the DOWN button until "CT" is reached. Press the MENU button. The setting value will flash.</p>
 	<p>Press the DOWN button until "OFF" is reached. Press the MENU button to confirm. The setting value will no longer flash.</p>
	<p>Press the ESCAPE button until returning to the normal display.</p>











### 3.8.9 Change Trip Levels















**CAUTION:** Consult all federal, state/provincial, or local requirements before adjusting trip levels. Do not set the trip level above what is allowed by a governing code, standard, or regulation

	<p>Press the MENU button.</p>
 	<p>Press the DOWN button until "Settings" is reached. Press the MENU button to enter the Settings menu.</p>
 	<p>Press the DOWN button until "Channel" is reached. Press the MENU button. Password entry will be required. A number of individual channel options will appear.</p>
	<p>Press the UP button until the numbers at the top of the screen are flashing. This is the channel selection option.</p>
	<p>Press the MENU button. The channel to apply settings to will flash.</p>
 	<p>Press the DOWN button until the desired channel number is selected. To apply the trip level change to all channels, select "1...12." Press the MENU button to confirm selection. Any settings changed now will only affect the selected channel(s).</p>
 	<p>Press the DOWN button until "Resp. Value" is reached. Press the MENU button. The setting value will flash.</p>
 	<p>Press the DOWN button until the desired trip level is reached. Press the MENU button to confirm the change. The setting will no longer flash.</p>
	<p>Press the ESCAPE button until returning to the normal display.</p>











### 3.8.10 Change Pre-Trip Alarm Level

	<p>Press the MENU button.</p>
 	<p>Press the DOWN button until "Settings" is reached. Press the MENU button to enter the Settings menu.</p>
 	<p>Press the DOWN button until "General" is reached. Press the MENU button. Password entry will be required.</p>
 	<p>Press the DOWN button until "Prewarning" is reached. Press the MENU button. The value will flash.</p>
 	<p>Press the DOWN button until the desired prewarning value is selected. Press the MENU button to confirm the change. The setting will no longer flash.</p>
	<p>Press the ESCAPE button until returning to the normal display.</p>

### 3.8.11 Change Trip Time Delay

	<p>Press the MENU button.</p>
 	<p>Press the DOWN button until “Settings” is reached. Press the MENU button to enter the Settings menu.</p>
 	<p>Press the DOWN button until “Channel” is reached. Press the MENU button. Password entry will be required. A number of individual channel options will appear.</p>
	<p>Press the UP button until the numbers at the top of the screen are flashing. This is the channel selection option.</p>
	<p>Press the MENU button. The channel to apply settings to will flash.</p>
 	<p>Press the DOWN button until the desired channel number is selected. To apply the trip level change to all channels, select “1...12.” Press the MENU button to confirm selection. Any settings changed now will only affect the selected channel(s).</p>
 	<p>Press the DOWN button until “T(on)” is reached. Press the MENU button. The setting value will flash.</p>
	<p>Press the DOWN button until the desired time delay is selected. Press the MENU button to confirm the change. The setting value will no longer flash.</p>
	<p>Press the ESCAPE button until returning to the normal display.</p>

### 3.8.12 Change Password

	<p>Press the MENU button.</p>
 	<p>Press the DOWN button until "Settings" is reached. Press the MENU button to enter the Settings menu.</p>
 	<p>Press the DOWN button until "Password" is reached. Press the MENU button. Password entry will be required. The password used is the factory setting, or the previously set password if it was changed.</p>
	<p>Press the DOWN button until "Password" is reached, which includes a set of three numbers.</p>
	<p>Press the MENU button. The first digit in the password will flash.</p>
	<p>Press the DOWN button to change the digit to the desired value.</p>
	<p>Press the MENU button to confirm. Repeat these steps for the next two digits. After pressing MENU on the last digit, the numbers will no longer flash.</p>
	<p>Press the ESCAPE button until returning to the normal display.</p>



### 3.8.13 Factory Default Settings Table

continues onto the following page.

		Range	MG-T.3 Factory Setting
Exit			
1. Alarm/meas.val.			
2. % Bar graph			
3. History			
4. Harmonics			
5. Data logger			
6. Settings	Exit		
	1. General		
	1. Memory	off on	on
	2. Prewarning	10 - 100%	70%
	3. Hysteresis	2 - 40%	15%
	4. Frequency	50Hz 60Hz 400Hz DC	60Hz
	5. T (Start)	0 - 99 sec	0 sec
	Exit		
	2. Preset		
	1. Factor	*1 - *99	1
	2. Offset	0mA - 20A	0
	3. Preset	Preset Cancel	
	3. Channel*		
	Chan.: _	1 .. 12 1,2,3 ..	
	Exit		
	1. Factor	*1 - *250 </2 - /10>	1
	2. Resp. Value	6mA - 20A	30 mA
	3. Mode	> < Off 0/1	>
	4. T(on)	0 - 999 sec	0.1 sec
	5. T(off)	0 - 999 sec	0.2 sec
	6. Cut-off	none 50Hz 60Hz IEC	none
	7. CT	Type A Flex Type AB	Type A
	8. CT monitor	on off	on
	9. OP-mode	N/O-T N/C-T N/C N/O on off	N/O-T
	Exit		
	4. Relay		
	Relay:: _	1 .. 2 1,2	
	Exit		
	1. Relay mode	N/O-T N/C-T N/C N/O on off	N/C-T
	2. Alarm	on off	K1: on // K2: off
	4. Prewarning	on off	K1: off // K2: on
	5. Device error	on off	K1: off // K2: on
	5. Exter. alarm	on off	K1: off // K2: off
	Exit		

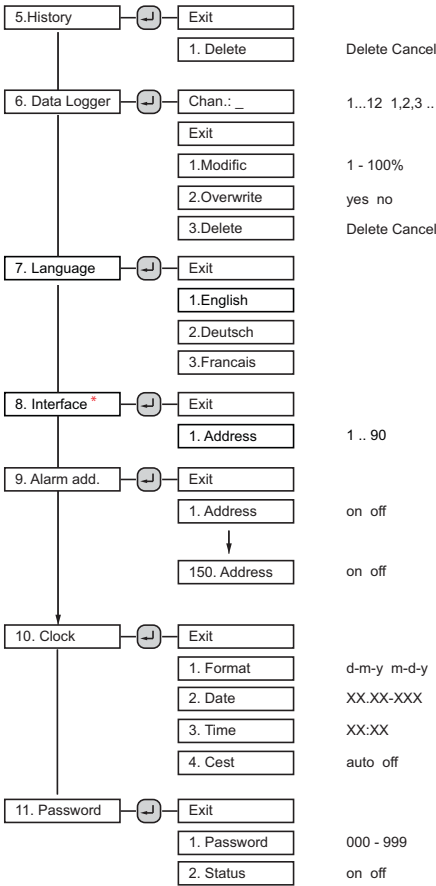

# 4. Operation

## 4.1 Panel Interface Elements

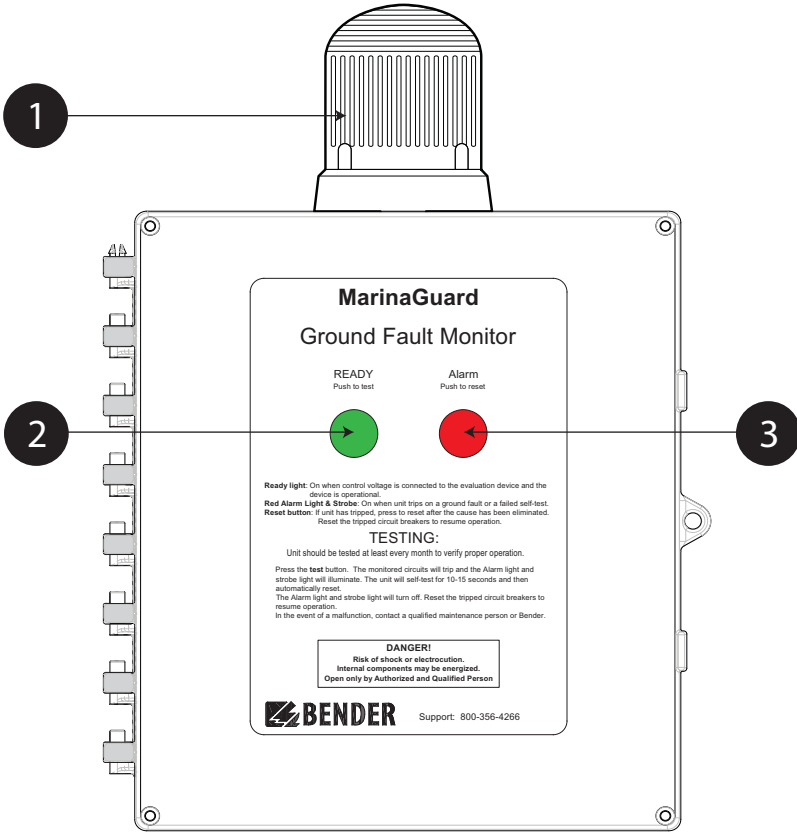

<b>1</b>	<p><b>Strobe light:</b>                  Flashes red when any circuit is tripped due to a ground fault, internal fuse has failed, or self-test has failed.</p>
<b>2</b>	<p><b>Ready light / Test button:</b>                  Illuminates green when panel is powered and internal RCMS490 is in the normal condition. Press and hold the button for at least 1.5 s to initiate a functional test. Refer to Section 4.3 (Page 28) for what occurs during a self-test.</p>
<b>3</b>	<p><b>Alarm light / Reset button:</b>                  Illuminates red when any circuit is tripped due to a ground fault, internal fuse has failed, or self-test has failed. Press and hold the button for &gt;1.5s to reset the system and return to the normal state. After the ground fault is eliminated, external trip devices can be reset.</p>

## 4.2 Applying Power

To apply power, close the circuit breaker or disconnect to the 120 VAC control power entering the panel. The MarinaGuard will immediately power on. The green READY light will illuminate.



---

**NOTE:** *During startup, the strobe may flash briefly and the red ALARM light may also illuminate briefly. This is normal power-up operation.*

---

## 4.3 Performing a Functional Test



---

**NOTE:** *performing a functional test will trip the circuit interrupting devices and de-energize the monitored circuit.*

---

- Press and hold the TEST button for at least two seconds. The red ALARM light will illuminate and the strobe light will activate.
- Wait 10 to 15 seconds until the internal self-test completes.
- The RCMS490 will automatically reset when the self-test is completed.
- Manually reset all connected circuit breakers.

## 5. Troubleshooting

### 5.1 General Troubleshooting

Condition	Possible Cause	Actions
No power to panel or connected circuits	De-energized or incorrect control power	If power indicator light on Control L1 terminal block is not lit, verify control connections for proper polarity. Verify external power supplied to panel.
	Internal circuit breaker open	Internal circuit breaker must be switched to ON for internal components and externally connected shunt trip breaker coils to receive power.
No power to internal ground fault relay	Blown fuse	Check condition of fuse protecting ground fault relay. Determine root cause of blown fuse and replace as necessary.
Unit does not reset after trip, test, or startup	Internal device error	Refer to Section 5.3 for error code information.
	Improper settings	Verify all settings are correct for the application. Verify any settings that must not be changed are the same as factory defaults.
Circuit does not trip on self-test	Inactive channel	Check RCMS490 settings to verify the respective channel is active.
Unit immediately trips after resetting connected shunt trip breaker	Ground fault	Verify any ground faults are cleared before resetting circuit breakers.

### 5.2 Fuse Replacement

Each panel contains quantity one of the fuse listed below.

Model	Fuse
MG-T.3	5 A / 250 V, type 3AG time-delay fuse

### 5.3 Error Codes

Error Code	Possible Cause / Actions
E.01 or E.02	CT connection monitoring failed. Verify current transformer is connected with proper polarity for k and l terminals.
All others	Contact Bender.

Error codes are shown on the internal RCMS490 display.

Error Code	Possible Cause / Actions
Channel X CT Connection	CT connection monitoring failed for the specified channel. Verify current transformer is properly connected. If channel is unused, disable the channel.
Device Error 71	No RS-485 master was detected. Ensure "Address" setting is set to the factory default of 1.
All others	Contact Bender.

### 5.4 Technical Specifications

Supply	120 VAC
Relay protection fuse	5 A type 3AG time delay
Internal overcurrent protection	15 A UL 489 circuit breaker
Ground-fault monitor	RCMS490-D-2
Pickup range	6 mA to 20 A (30 mA factory setting)
Trip delay range	0 to 999 s (100 ms factory setting)
System Current	1 A RMS, 5 A peak
Output Contact Rating Current	2 A (utilization category AC-13) 0.5 A (utilization category AC-14)
Maximum protected-circuit voltage	600 Vac
Current withstand rating	160 A, 1 s
Dimensions (W x H x D)	13.4 x 18.75 x 7.87" (340 x 476 x 200 mm)
Weight	10 lb (4.5 kg)
Shipping weight	12 lb (5.5 kg)
Compatible current transformers	CTAC series
Compatible trip device	shunt trip, 120 Vac
Field connections	Copper wire only, 22 to 14 AWG, 60/70 C
CT-input and shunt-trip terminals, torque	4.2 to 4.6 lb-in (0.5 Nm)

## 6. Ordering Information

### 6.1 MarinaGuard

Part No.	Channels	Outputs	Ordering No.
MG-T.3	12	12	B541300779

### 6.2 Current transformers

One current transformer is required per measurement channel. Current transformers must be large enough to accommodate all normally energized conductors (including the neutral if it is used) centrally though the opening.

Part No.	Shape	Core Type	Opening Size	Ordering No.
CTAC20	Circular	Solid	.79" (20 mm)	B 981 10005
CTAC35	Circular	Solid	1.38" (35 mm)	B 981 10007
CTAC60	Circular	Solid	2.36" (60 mm)	B 981 10017
CTAC120	Circular	Solid	4.72" (120 mm)	B 981 10019
CTAC210	Circular	Solid	8.27" (210 mm)	B 981 10020

## 7. Certifications

### 7.1 MarinaGuard

MarinaGuard® panels are UL Listed Ground-Fault Protection for Equipment (GFPE), file numbers KDAX.E478610 and KDAX7.478610.



GROUND FAULT SENSING AND RELAYING EQUIPMENT  
**E478610**



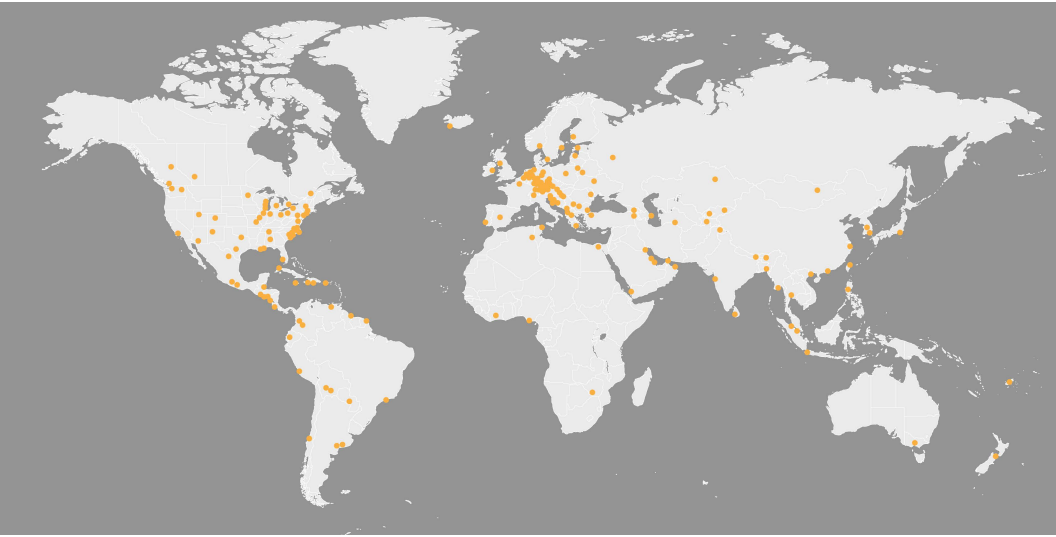

**USA • Exton, PA**  
+1 800.356.4266  
info@benderinc.com  
www.benderinc.com

**Canada • Mississauga, ON**  
+1 800.243.2438  
info@bender-ca.com