

Electrical safety in power plants and substations







Bender solutions for sustainable and reliable operation of power plants and substations

High reliability and efficiency are key factors to ensure that power plants and substations can be operated economically. Bender systems enable high availability and electrical safety at the same time. They ensure continuous monitoring of the plant.

Electrical safety in power plants and substations

| | |
|---|----|
| Maximum safety and economic efficiency | 4 |
| Monitoring of control circuits..... | 6 |
| Insulation monitoring in coupled systems | 8 |
| Generator monitoring | 9 |
| Continuous monitoring of de-energised loads..... | 10 |
| Analogue undervoltage/overvoltage relays | 11 |
| Measuring without switch-off acc. to IEC 60364-6..... | 12 |
| Power quality and power consumption recording | 13 |
| POWERSCOUT® | 14 |
| System control centre..... | 15 |
| Support during all stages | 16 |
| Why the IT system is often the better choice | 17 |

Safety, high availability and economic efficiency for power supply in power plants

Operational failures, malfunctions or circuit interruptions within a power plant are among the worst-case scenarios for operators and those in charge, since every failure or malfunction in these highly available systems and installations can be very costly.

In order to ensure a high level of reliability and fail-safe operation, selecting the right protection technology and the right system type is of particular importance. The effects of problems that can be detected at an early stage are usually underestimated and range from the sudden triggering of protective devices to fire, environmental damage or even injury to persons.

Often the choice of the system type is a matter of habit, not of cost, technology or safety. The advantages of an IT system (unearthed) are obvious, especially for critical systems in power plants and substations.

Designing the electrical system as an IT system guarantees less downtimes, facilitates maintenance, reduces the fire risk and thus leads to higher returns and lower costs in the long term.

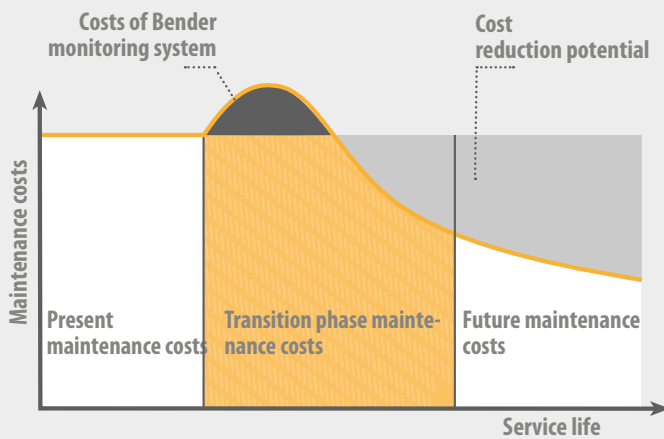

Bender monitoring systems ensure a fault-free power supply and thereby offer convincing advantages to the operator of electrical installations.

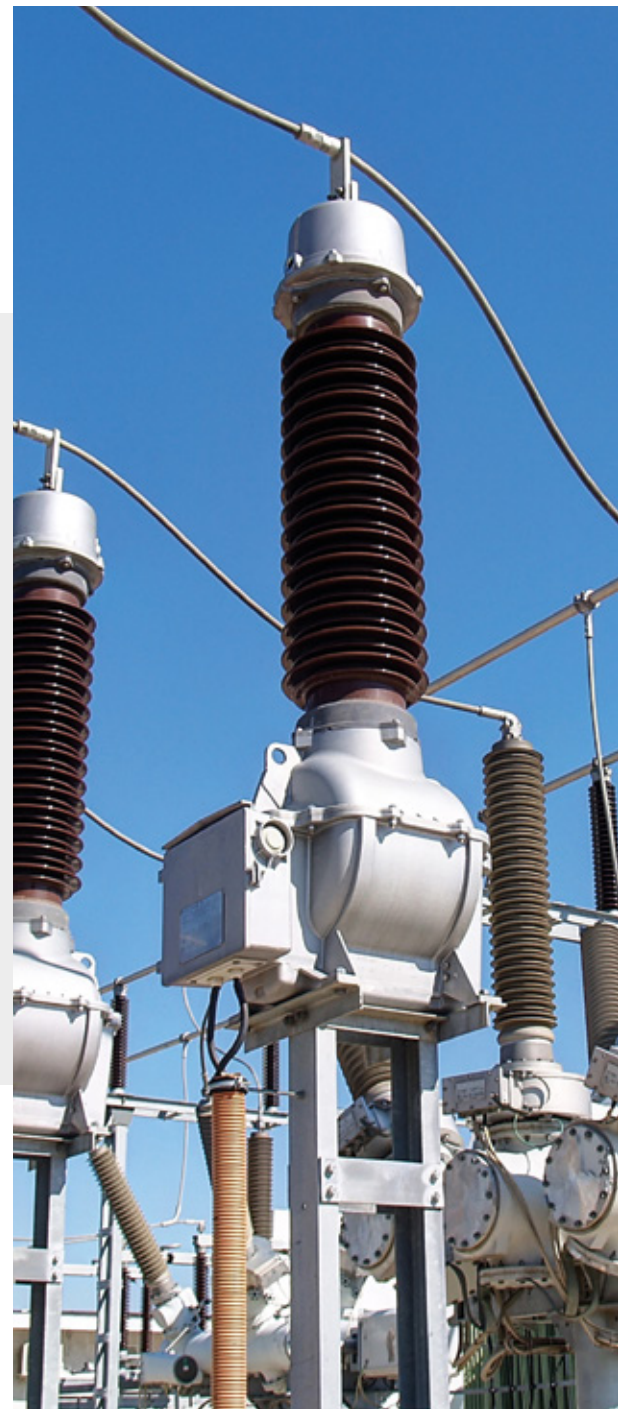

For this reason, unearthed systems with a suitable insulation monitoring device are already required by the standards, e.g. DIN VDE 0100-560 (VDE 0100-560):2013-10 for safety services.

Our years of experience working closely with the energy sector makes us the right contact partner for the safety of your electrical installation.

As your partner, we use our know-how combined with the quality of our pioneering work in the field of electrical safety to guarantee the highest possible level of availability and safety for your electrical installation. This way you are always on the safe side.

Maintenance strategies

Corrective

Downtime-oriented

- Reaction after direct damaging event
- Unscheduled downtime

Preventive

Time-dependent

- Established deadlines
- Frequent exchange of intact components

Condition-oriented

- Reaction to warning thresholds concerning the system condition, prior to downtime
- Optimum use of service life (wear margin)

Predictive

Analysis-supported monitoring

- Forecast of the ideal point in time for maintenance
- Plannable maintenance measures

Continuous monitoring of auxiliary and control circuits for maximum availability

The advantage of an unearthed system: Knowing what will happen.

The electrical system that a power plant requires for operation needs the so-called auxiliary and control voltage circuits. These must be continuously and reliably monitored to guarantee the safety of the installation. An undetected electrical fault frequently results in unplanned system downtimes or increases the risk of fire significantly. Especially systems with an isolated star point (IT system) show their advantages here. Because a fault does not lead to a failure but to an acoustic and visual signal from the insulation monitoring device. For this reason, DIN VDE 0100-557 (VDE 0100-557): 2014-10 Selection and erection of electrical equipment – Auxiliary circuits for applications requiring high availability recommends an unearthed system.

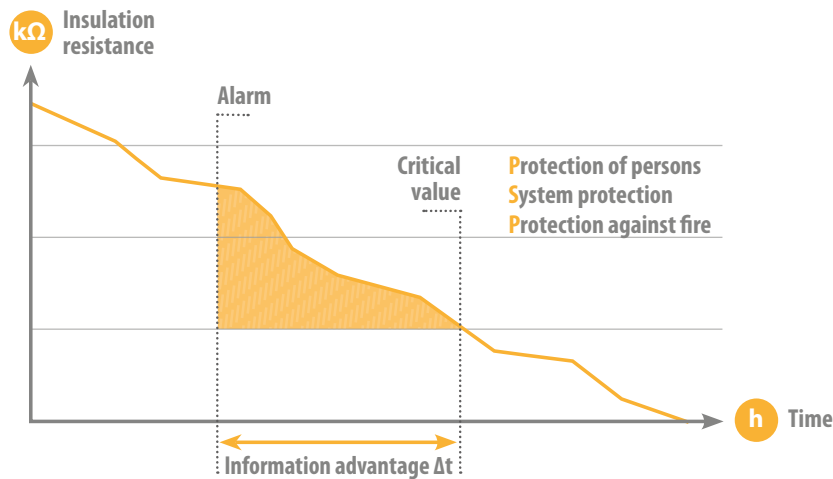

Reliable and efficient

Monitoring the auxiliary and control voltage in AC or DC systems is essential for the operation of power plants and substations. As an optimum addition to the required insulation monitoring device in the unearthed system, DIN VDE 0100-530 (VDE 0100-530):2014-10 recommends a modern insulation fault location system. With an iso685-...-P insulation monitoring device, an EDS440/441 insulation fault locator and suitable current transformers, insulation faults are located in a reliable and precise way. This advanced measurement technology is a standard-compliant solution and reliably informs you about all insulation fault types in the system, and whether they are asymmetrical or symmetrical.

Choosing the right type of monitoring - Bender know-how makes it easy

Insulation monitoring devices and insulation fault location systems can be retrofitted. The basic requirement is a system with an isolated star point. Bender provides standard-compliant state-of-the-art solutions and offers advice on the selection of the most suitable monitoring system.

Insulation monitoring device
iso685



- Combination of modern measurement methods
- Ethernet interface
- For systems up to AC 690 V, DC 1000 V

Insulation fault locator
EDS440/EDS441



- Up to 600 channels
- Two alarm relays
- High sensitivity with large system leakage capacitances



Only active measurement is correct measurement

The product standard DIN EN 61557-8 VDE requires that insulation monitoring devices must detect both symmetrical and asymmetrical faults. As a result, the "3-lamp systems" or "Voltmeter methods" often used in the past are no longer permissible. Bender provides standard-compliant solutions for new installations as well as for retrofitting measures.

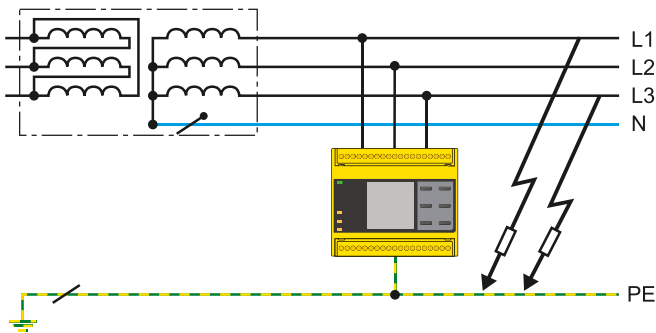

Bender insulation monitoring devices signal symmetrical faults that cannot be detected using traditional methods.

The Bender ISOMETER® and the insulation fault location system not only comply with the relevant product standards (IEC 61557-8, IEC 61557-9), but also offer practical functions with numerous advantages. These include, for example, an installation wizard or the web server, which allows individual settings and the assignment of customised texts.

Insulation fault locator EDS195P



Portable Bender insulation fault location systems complement Bender systems perfectly. They help locate faults in a fast and precise way.



Standard-compliant insulation monitoring in coupled IT systems

In power plants and substations, specific parts of the electrical systems are dimensioned according to the principle of the (n-1) safety criterion, in nuclear power plants, (n-2) criterion. The principle states that in an electrical grid with forecasted maximum transmission and supply tasks, grid safety must be guaranteed even if a component, such as a transformer or a circuit, fails or is switched off. The resulting redundant structure of the electrical systems is a particular challenge for the monitoring technology in the installation.

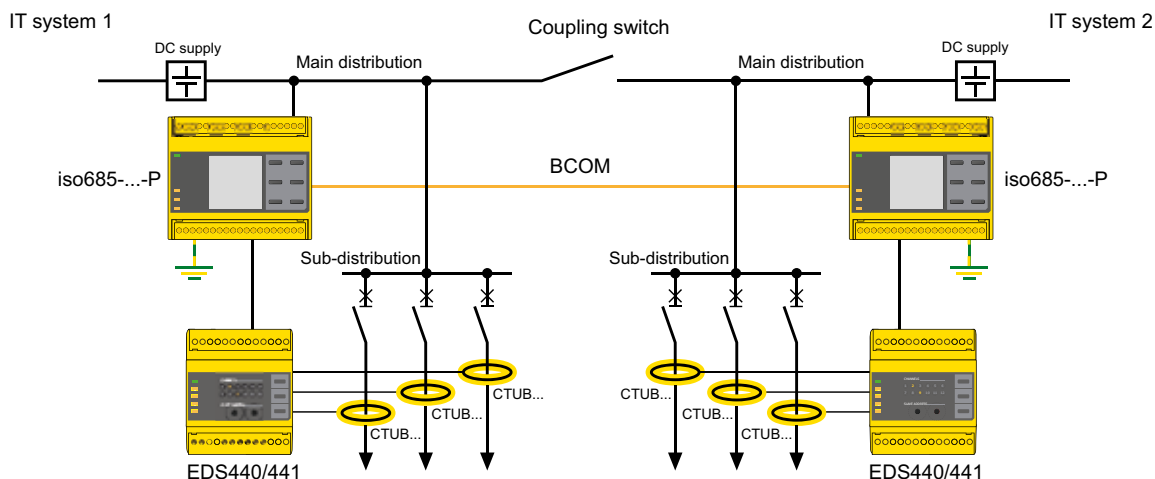

For power supplies connected in parallel, DIN VDE 0100-530:2014-10 requires an insulation monitoring device for each infeed. The insulation monitoring devices must be interconnected in such a way that only one device performs a measurement, regardless of the state of the coupling switch.

The ISOMETER® variants with ISONet function (iso685-D-B or iso685-D-P) are a standard-compliant solution, since this function enables the operation of several insulation monitoring devices in coupled systems without any mutual interference.

When an ISOMETER® has detected an insulation fault, the insulation fault location is initiated. The EDSsync function and the EDS440/EDS441 insulation fault locators reliably locate insulation faults even in coupled systems. This allows reliable fault diagnosis and also proactive and fast maintenance measures. In addition, the EDSsync function enables insulation fault location in diode-decoupled systems, such as those used in most power plant and substation supply systems.

To make sure everything works in case of an emergency: Monitoring an Uninterruptable Power Supply (UPS)

Specific parts of a power plant, such as the control voltage, must not fail. These systems are connected to a UPS. The electrical safety of UPS systems must be generally and continuously monitored.

Monitoring UPS systems by means of the Bender ISOMETER® provides optimum availability and ensures proper function in case of an emergency, since not all malfunctions in the UPS are immediately visible. An ISOMETER® detects and signals these problems, and offers you quick diagnostic steps or preventive measures.



Generator monitoring in power plants

A large part of the world's entire energy production is generated by rotating machines. As generators, these convert mechanical energy into electrical energy in power plants of all kinds. Reliable operation is a prerequisite for a well-functioning energy supply.

The problem of ageing

Electrical machines contain insulation and several carbon brushes that are subject to rapid ageing, which in turn leads to failures. The best way to prevent failures is to continuously monitor the condition of the electrical machines via its insulation state. Insulation monitoring can be realised both as online and offline monitoring. This continuous insulation monitoring allows potential problems and risks to be quickly identified. The high harmonics caused by the excitation system of the generator can also be taken into account when measuring the insulation with an ISOMETER®.

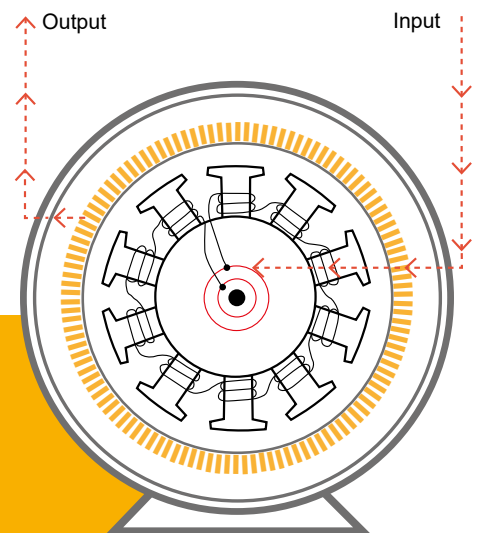

The solution

Early detection through continuous monitoring by means of an ISOMETER®

€ This measure is proven to reduce your maintenance costs.

... Deterioration of the cable insulation

... Damage to the excitation system

... Pollution in the electrical grid



Monitoring of de-energised systems

Always ready, always reliable

In the case of temporary or predominantly de-energised loads, such as fire pumps, slide-valve drives, lift motors or emergency power generators, insulation faults may occur during downtime due to moisture or other factors on the supply line or the load. Without monitoring, these insulation faults are not detected and therefore, the protective device may prevent operation when the system is switched on or in more severe cases, engine fires may occur.

In these cases, the use of special offline ISOMETER®s is easy and efficient. Also, the operator can be sure that the installation can be operated whenever it is needed.

The following systems must be continuously monitored so that they are ready for operation when required:

- Automatic fire pumps
- Emergency slide-valve drives (gas, water)
- Motor-controlled locking systems
- Submersible pumps, cooling water pumps, pumps
- Lifts, anchor windlasses
- Flue gas dampers
- Emergency power generators

Standard-compliant solution

A prerequisite for offline measurement is an automatic disconnection and connection of the insulation monitoring device according to the operating state of the predominantly de-energised loads as required in DIN VDE 0100-530 (VDE 0100-530), 538.3:2014-10. The Bender offline ISOMETER® complies with this standard and is therefore the ideal choice for this application.

If the insulation resistance of predominantly de-energised systems is not continuously monitored, the following risks exist when the system is switched on:

Protective device does not trip, the faulty system is started

High fault current leads to fire, damage to property, high costs

Protective device trips and prevents the device from powering up

Critical in case of e.g. fire pumps, gas slide valves and lifts

Solution: Monitoring with an ISOMETER®



Analogue undervoltage/overvoltage relays

Proven analogue technology

Power plant operators who decide against using software-directed device functions in the future require a reliable analogue solution.

This is guaranteed by the VMD258. The fully analogue function **prevents** any of the dynamic faults that are hard to detect, e.g. those caused by faulty software, from occurring.

Undervoltage/overvoltage relays for monitoring of three-phase AC systems up to 690 V in purely analogue technology

The voltage relay VMD258 from Bender monitors three-phase AC systems for undervoltage and overvoltage (window function). A star point connection is not required, which makes it suitable for 3 AC systems up to 690 V. The supply voltage for the electronics is provided by the system to be monitored. The supply for the electronics, the relays and the connection for the external energy storage device are isolated from the system by means of double isolation.

Normative basis

The analogue VMD258, which is adjusted to the special requirements of the power supplies in power plants and substations, complies with the following device standards:

DIN EN 60255-1 (VDE 0435-300):2010-09 and
DIN EN 60255-127 (VDE 0435-3127):2015-10.

What happens in the event of a power failure?

Even in the event of brief power failures, the availability of the protective devices and monitoring devices must be guaranteed. For these particular cases, the VMD258 can be expanded with the energy storage device ES258 in order to bridge the voltage supply for at least 5 s in the event of a power failure.

Undervoltage/overvoltage relay VMD258



- No external supply voltage required
- Completely analogue
- For 3AC up to 690 V
- Acc. to IEC 60255-127

How about something a little more digital...?

Bender offers a wide product range of digital and multifunctional monitoring relays for various application areas in AC or DC systems.

Continuous monitoring of residual currents: Measuring without switch-off by means of periodic verification

Companies or power plant operators are responsible for the safety of their employees. Among other things, they must assess the danger of electrical systems and equipment and implement the requirements of the German Social Accident Insurance (DGUV) Regulation 3 (formerly BGV A3) or DGUV Regulation 4 for public accident insurance institutions (formerly GUV-V A3).

In order to maintain the correct status for electrical installations and stationary electrical equipment, periodic verification must be carried out. Section 5, paragraph 1, no. 2 of DGUV Regulation 3 states that this requirement is also fulfilled if the system is continuously monitored by an electrically skilled person. The time-consuming insulation measurement, which is usually difficult to perform, is therefore not necessary if the electrical system is monitored in accordance with the basic standard DIN IEC 60364-6 (VDE 0100-600):2017-06 by a residual current monitoring system in accordance with IEC 62020 or an insulation fault location system in accordance with IEC 61557-8. The Bender ISOMETER®s as well as the RCM series fulfil the standard and are ideally suited for the application.

Bender technology eliminates the need for the time-consuming insulation measurement required by DGUV Regulation 3 and thus offers electrically skilled persons an ideal solution for monitoring in accordance with the regulations.

This makes the often unfeasible disconnection of devices for measurement and a shutdown of the system a thing of the past. Likewise, no expensive business interruptions are necessary. The Bender ISOMETER® also performs the self-test required by DIN IEC 60364-6 (VDE 0100-600):2017-06 fully automatically.



Power quality and energy measurement

Transparency for electrical installations

Frequently, failures and disturbances are caused by overloaded networks. By means of a monitoring system with universal measuring devices from the PEM series, potential impacts on protective measures, hazards due to overloads or changes in power consumption can be evaluated already before reaching the next expansion stage.

The aim of a monitoring system must always be to detect even small changes in the relevant measured quantities, such as leakage current or harmonic content, and issue a prewarning in the event of deviations as early as possible.

Trends of relevant measured quantities for voltage quality or leakage currents cannot be monitored properly with a single measuring point in an electrical installation. Several measuring points are required which must be adjusted to the system structure.

Structure of the monitoring system

A granular, i.e. fine-grained structure of the monitoring system allows:

- Cost centre specific energy data acquisition
- Faster localisation in the event of a fault
- Economic pyramid structure

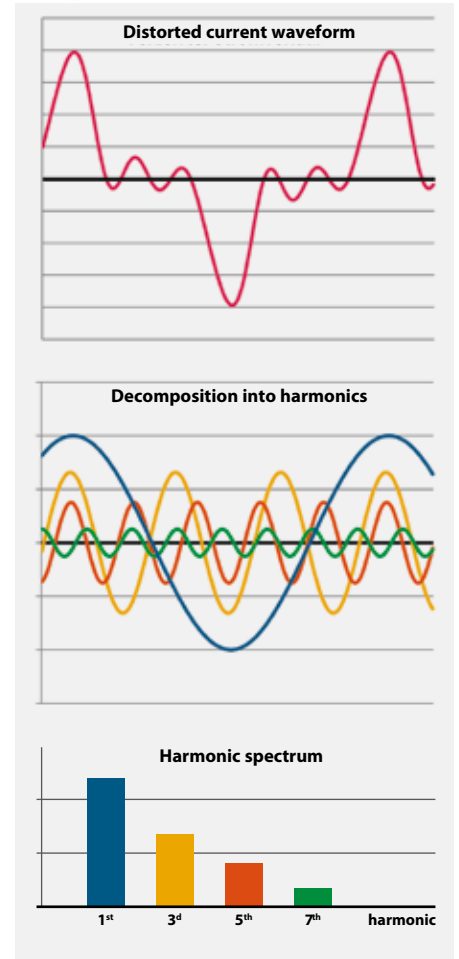

— Fundamental — 5th harmonic
— 3^d harmonic — 7th harmonic



POWERSCOUT®

Find out today what won't happen tomorrow

Malfunctions occur in every electrical installation due to moisture, ageing, dirt, mechanical damage or faults caused by the impact of current, voltage and temperature. The web-based software solution POWERSCOUT® helps you detect these at an early stage and eliminate the causes in an economically reasonable way. This guarantees high system and operational safety and reduces costs.

Analysis – as individual as your installation – as easy as possible

Predictive maintenance prevents failures, saves costs and personnel deployment. With POWERSCOUT® you know the status of your electrical system at all times, because the meaningful visualisations with flexible dashboards can be called up via any display device, whether it is a smartphone, tablet or computer. On request, POWERSCOUT® will send you these graphically processed reports at specified intervals.

Continuous monitoring instead of random checks

Manual data acquisition is time-consuming, error-prone and only provides random results. POWERSCOUT® gives you an insight into the entire data of your system at any time, since all measured values are automatically and continuously saved. Your data is stored reliably and remains available for years.

Basis for periodic verification

The automated POWERSCOUT® report on residual currents forms the basis for measuring without switch-off by means of periodic verification. For electrical installations and stationary electrical equipment, periodic verification must be carried out to maintain the proper condition, for example by means of continuous monitoring of the installation by electrically skilled persons.

It is a clever idea to use continuous monitoring with multi-channel residual current monitoring systems (RCMS) and an evaluation unit adapted to the system (e.g. CP907-I). The automatic reports from POWERSCOUT® based on this enable the responsible electrically skilled person to adjust the deadlines for insulation testing as part of the periodic verification.

Analysis

- Continuous recording of insulation values
- Identify connections and optimise processes
- Cross-plant evaluation options
- Access from any location
- Support of investment decisions

Predictive maintenance

- Higher availability
- Continuous monitoring
- Early detection of gradually developing insulation faults
- Detect short-term deteriorations in insulation values at an early stage
- Less costs due to unexpected malfunctions and shutdowns

Report

- Historical comparisons
- Reliable storage of measured values
- Event and alarm statistics

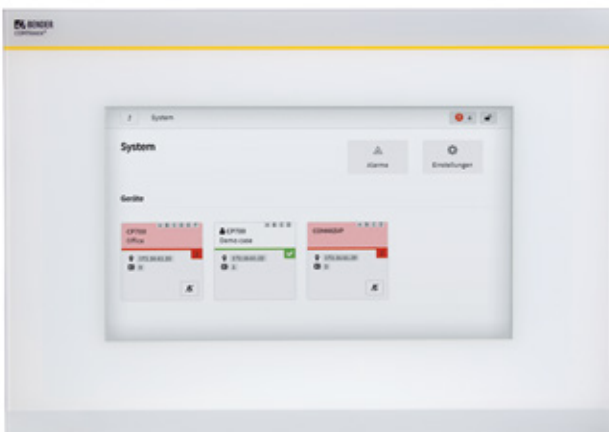

Application example CP907-I

System control centre

LINETRAXX® monitoring systems are used in a wide range of applications. However, what they all have in common is that the user can obtain relevant information in a fast and easy way. In the event of an alarm, the system informs actively via e-mail, switching contacts or by forwarding information to higher-level control systems. To carry out an analysis or create a report, the user accesses data points that were captured previously. The Bender system control centre allows both in one system. Data is collected from all connected measuring devices, evaluated and processed according to the respective application. In doing so, the browser-based concept offers many advantages:

- All users work in a live system (no local system images have to be administered manually)
- Additional users can access the system with any browser-enabled device (no user licence or additional hardware required)
- Scalable and future-proof due to possibility of expansion (no additional hardware required for system expansions)
- Software updates are only carried out centrally (no local administration of access or evaluation software)
- Real-time support via Bender Remote Assist



From the complete system overview with integrated visualisation tool to detailed power quality evaluations, the Bender system control centre assists the user with intuitive operation and guided support during fault analysis.

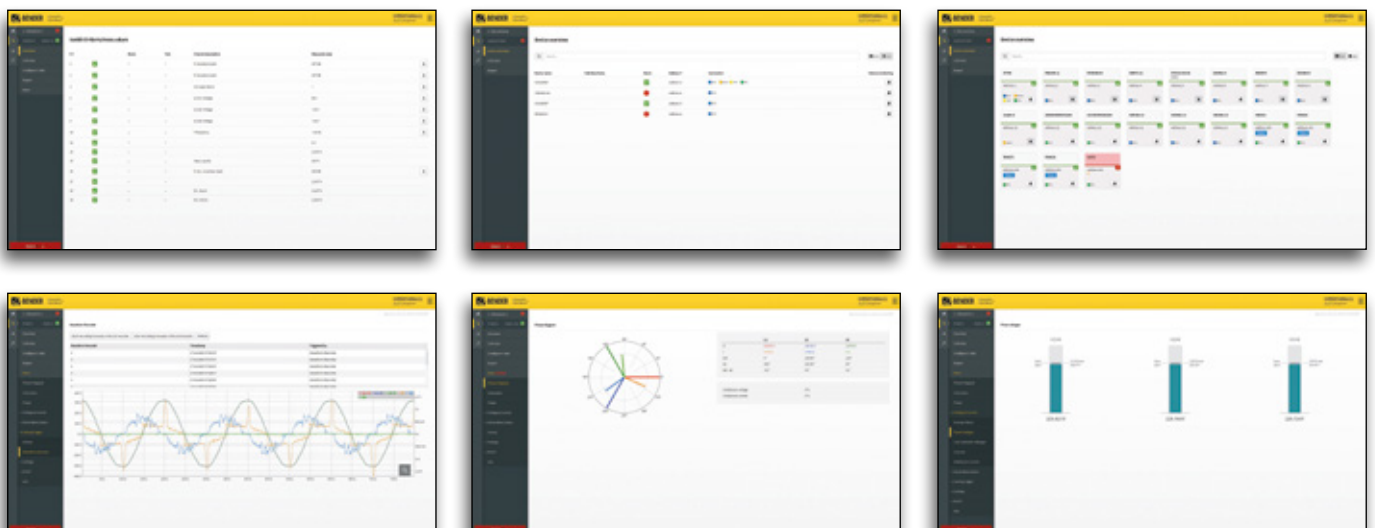

Display of device data on the web user interface (COM465IP)

Support during all stages

Comprehensive service for your installation: remote, by telephone, on site

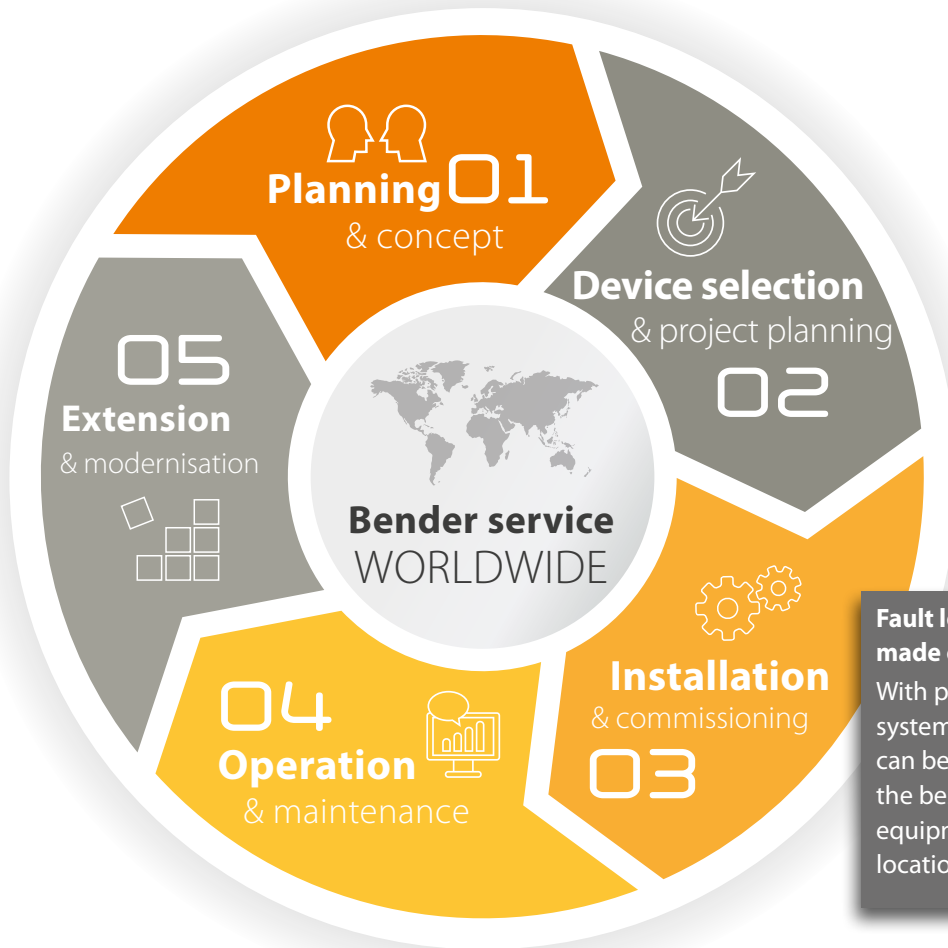

Competent service for maximum safety and high availability of your installation



Fault location – made easy

With portable fault location systems, existing insulation faults can be quickly located. They are the best alternative if no stationary equipment for insulation fault location is available.

From planning to modernisation – We are available to assist you during all stages of your project with our extensive know-how.

In addition, with our first-class service we guarantee maximum safety for your electrical systems.

We offer services ranging from support over telephone to repairs and on-site service – with modern measuring devices and competent employees.

Secure yourself:

- High availability of your system thanks to fast reaction to fault messages
- Increased profitability of your capital expenditure (CAPEX) via optimised maintenance processes
- Targeted operating expenditure (OPEX) due to less downtimes and shorter service visits
- Support for your predictive system monitoring and regular tests of your system/power quality/monitoring devices
- Automatic control, analysis, correction, new settings/updates
- Competent support with setting modification and updates

Bender Remote Assist

Bender Remote Assist offers you support via remote access, high-quality service and advice for your challenging task consisting in ensuring consistent high safety in your systems.

Many service visits, fault clearance but also analysis and controls can be carried out remotely – without the expenses of time and money that an on-site visit of a technician implies.

This fast, efficient help and advice by our expert network allows the highest possible availability of your system.

Why the IT system is often the better choice



Goal: Reliable power supply – high availability

Due to increasing complexity and automation, technical installations depend more and more on a reliable power supply.

At the same time, the follow-up costs of unexpected failure increase. The selection of the power supply system already determines how well a reliable power supply and high availability of the system can be implemented later.

TN system, TT system or IT system?

In principle, planners can choose between different system types, which differ in the structure with regard to the earthing ratios of the power source and equipment as well as in the design of the neutral conductor and the protective conductor. Looking at all the options, the conclusion is that the IT system is usually the preferable choice as system type.

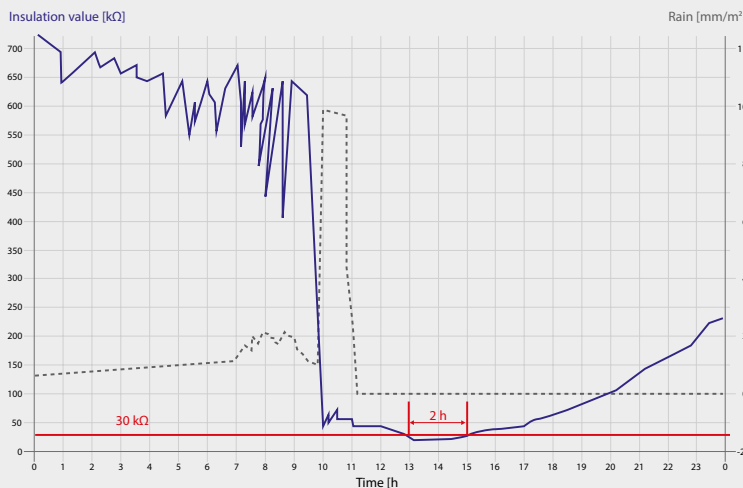

Another plus: Operators are given the opportunity to evaluate system data according to their own needs and to use it to improve the system, as well as to correlate the measurement data with other events in the power plant. This helps to find the causes of short-term insulation faults, since often maintenance teams cannot react to fault messages within a few hours, locate and eliminate them. In this case, stationary equipment for insulation fault location offers a decisive advantage.

The five major advantages of an IT system:

Advantage 1: Continued operation on first insulation fault

One of the decisive advantages of the unearthed system (IT system) is that even if a low-impedance insulation fault occurs, the system can continue to be operated.

Advantage 2: Protection against fire

Insulation faults are the most common cause of fire. IT systems reduce the risk of fire caused by insulation faults to a minimum, which is also rewarded by insurance companies through lower insurance premiums.

Advantage 3: Fault location during operation

With suitable equipment, fast insulation fault location is possible without interrupting operation.

Advantage 4: Less test effort

Since insulation monitoring devices eliminate the need for Riso measurement during periodic verification, both costs and time are saved. Thus, no interruption of operation is necessary.

Advantage 5: Increased protection of persons

System operators who implement IT systems offer their employees, visitors and customers the greatest possible protection.

Due to the various economic and technical advantages, an unearthed system with high-performance insulation monitoring is almost always profitable in rather complex installations.

Safety for power plants - cost savings through reduced downtime

Bender offers a practical solution that pays off and provides more safety. We are happy to advise you and find individual solutions for your needs and your technical application.

Please do not hesitate to contact us at www.bender.de

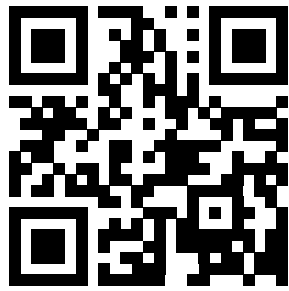

Bender. So that your world is safer.

Our world is networked on a global scale; it is digital, mobile and highly automated – whether in manufacturing industry, inside or outside buildings, in operating theatres and power stations, in trains, underwater or underground: it never stands still and it is more dependent than ever on a reliable and, above all, safe electrical power supply.

And exactly that is our mission: we make electricity safe. With our technologies, we ensure that electricity is permanently available and guarantee faultless protection against the hazards of electric shock. We protect buildings, plants and devices and therefore your investments and plans. But what we primarily protect are the lives of the people who are involved with electricity.



Mechanical and plant engineering



Healthcare



Oil, gas



Renewable energy



Public power supply network

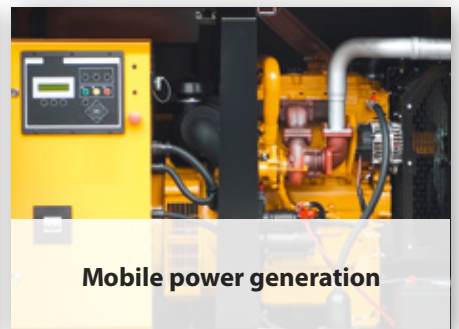

Mobile power generation



Ships and ports



Railway



eMobility

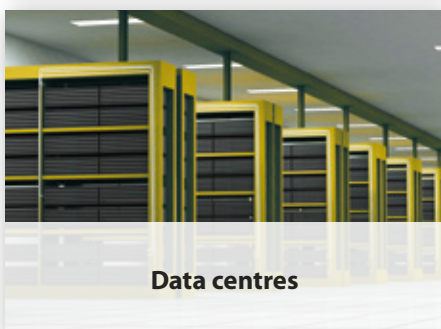

Data centres



Mining

www.bender.de



Bender GmbH & Co. KG

Londorfer Straße 65 • 35305 Grünberg • Germany

Tel.: +49 6401 807-0 • info@bender.de • www.bender.de

Fotos: iStock (© Petair), Adobe Stock (© annavaczi, © kostas_iliev, © Rafael Classen, © CatonPhoto.com, © Ramona Heim, © Rainer Fuhrmann, © elgris, © tomas), 123RF (© Paolo Sartorio, © Gerard Koudenburg, © stefan77, © Volker Rauch), Thinkstock (© monkeybusinessimages) sowie Bender Archiv.



BENDER Group